



**YOUR SOURCE FOR**

**EQUIPMENT  
PARTS &  
SUPPLIES**

**2019 FALL FLYER**



**#1 BEST  
SELLING  
AMERICAN  
MADE**

**PICK 2!**

**GET AN ULTRAVAC 2100  
WITH YOUR PICK OF ANY  
2 OPTIONS FOR ONLY**

**\$16,495**

# OEM & AFTERMARKET PARTS

VIEW  
PAGE



Maintain optimal performance and extend the life of your processing, packaging and labeling machines with UltraSource parts. UltraSource offers a large parts inventory and can consult with you to ensure you are getting the parts you need.

**CALL 800.777.5624 TO TALK WITH A PARTS SPECIALIST TODAY.**



## VACUUM PACKAGING

- » Oil
- » Oil Filters
- » Seal Bars
- » Teflon Tape
- » Lid Gaskets
- » Lid Springs
- » Seal Bladders
- » Exhaust Filters

## ROLLSTOCK

- » Sealing Gaskets
- » Calrod Heaters
- » Sealing Bladders
- » Film Grippers
- » Transport Chains
- » Blades
- » Seal Bars Repair & Finish

## PROCESSING

- » Blades
- » Needles
- » O-rings & Gaskets
- » Smokehouse Parts
- » Conveyors



## LABELING

- » Rollers
- » Bearings
- » Sensors
- » Gear Box Motors
- » Tamp Blades
- » Label Reel Discs
- » Peel Bars

# SEASONINGS

## Custom blends and bulk spices now available!

Our experts can pre-mix your custom blend so you can use your time and labor more efficiently while being sure that the recipe is perfect each and every time.

Using only the finest ingredients available we'll ensure that your finished product attains the specific flavor you desire, and rest assured that all proprietary recipes submitted are protected by a non-disclosure agreement.

## STOCK BLENDS

VISIT OUR  
WEBSITE OR  
CALL FOR A  
FULL LIST!  
888.997.6824

## CUSTOM BLENDS

CALL US TODAY TO  
DISCUSS A CUSTOM  
BLEND OR GET A  
QUOTE ON YOUR  
EXISTING BLEND



# POLY MEAT BAGS, TAPE DISPENSER, STAPLER



## POLY MEAT BAGS

### FEATURES:

- » 1-lb. and 2-lb. bags feature 1" bottom gusset
- » 1,000 bags per box
- » Safe handling instructions included on back side of "For Sale"
- » 2 mil thickness
- » Distinctive designs including Premier Plaid® and Camo available

**NOTE:** Free customization offer not available on clear or white bags

### "NOT FOR SALE"

Item #	Description	Size (in)	Price / Box	SALE PRICE
190001	Ground Beef, 1-lb., NFS	4.5 x 10	<del>\$36.58</del>	\$32.92
190011	Ground Beef, 2-lb., NFS	4.5 x 13.5	<del>\$38.83</del>	\$34.95
190021	Ground Beef, 5-lb., NFS	6 x 18	<del>\$57.11</del>	\$51.40
190005	Wild Game Camo, 1-lb., NFS	4.5 x 10	<del>\$37.63</del>	\$33.87
190015	Wild Game Camo, 2-lb., NFS	4.5 x 13.5	<del>\$40.93</del>	\$36.84
190003	Wild Game, 1-lb., NFS	4.5 x 10	<del>\$36.58</del>	\$32.92
190013	Wild Game, 2-lb., NFS	4.5 x 13.5	<del>\$38.83</del>	\$34.95
190002	Pork Sausage, 1-lb., NFS	4.5 x 10	<del>\$36.58</del>	\$32.92
190012	Pork Sausage, 2-lb., NFS	4.5 x 13.5	<del>\$38.83</del>	\$34.95
190004	Ground Pork, 1-lb., NFS	4.5 x 10	<del>\$36.58</del>	\$32.92
190014	Ground Pork, 2-lb., NFS	4.5 x 13.5	<del>\$38.83</del>	\$34.95

### "RETAIL"

Item #	Description	Size (in)	Price / Box	SALE PRICE
190006	Ground Beef, 1-lb.	4.5 x 10	<del>\$36.58</del>	\$32.92
190016	Ground Beef, 2-lb.	4.5 x 13.5	<del>\$38.83</del>	\$34.95
190007	Pork Sausage, 1-lb.	4.5 x 10	<del>\$36.58</del>	\$32.92
190017	Pork Sausage, 2-lb.	4.5 x 13.5	<del>\$38.83</del>	\$34.95
190008	Ground Pork, 1-lb.	4.5 x 10	<del>\$36.58</del>	\$32.92
190018	Ground Pork, 2-lb.	4.5 x 13.5	<del>\$38.83</del>	\$34.95

Item #	Description	Size (in)	Price / Box	SALE PRICE
190030	Plain White, 1-lb.	4.5 x 10	<del>\$36.58</del>	\$32.92
190031	Plain White, 2-lb.	4.5 x 13.5	<del>\$38.83</del>	\$34.95
190032	Plain White, 5-lb.	6 x 18	<del>\$57.11</del>	\$51.40
190039	Clear, 1-lb.	4.5 x 10	<del>\$31.15</del>	\$28.04

**FREE**  
BAG CUSTOMIZATION  
WHEN YOU PURCHASE 10 OF  
THE SAME SIZE AND STYLE.

**CALL TODAY**  
FOR YOUR  
**FREE**  
SAMPLE!

## STAINLESS STEEL BAG TAPE DISPENSER

- » Instantly closes bag and cuts tape
- » Uses less than 2" of tape with each seal
- » Side trimmer removes excess
- » Perfect for damp environments



Item #	Description	Price/Each	SALE PRICE
531001	Stainless Steel Bag Tape Dispenser	<del>\$28.95</del>	\$26.06
531000	Painted Bag Tape Dispenser	<del>\$18.95</del>	\$17.06
531004	Stainless Steel Replacement Blade	<del>\$1.99</del>	\$1.79

Item #	Description	Price / Roll	SALE PRICE
531002	Red Tape (180 yards)	<del>\$3.75</del>	\$3.38
531003	White Tape (180 yards)	<del>\$3.75</del>	\$3.38
531005	Yellow Tape (180 yards)	<del>\$3.75</del>	\$3.38
531006	Green Tape (180 yards)	<del>\$3.75</del>	\$3.38

## HAND HELD BAG STAPLER

- » Economical alternative to clipping systems
- » Special bag sealing throat plate assures a tight seal with every staple (2-5/8" throat depth)
- » Rust and water resistant chrome finish wipes clean with a damp cloth



Item #	Description	Price	SALE PRICE
541001	Hand Held Bag Stapler	<del>\$41.95</del>	\$37.76
541002	3/8" Staples, 5,000 per box	<del>\$11.95</del>	\$10.76

# VACUUM POUCHES



» Our pouches deliver amazing reliability while featuring exceptional optical qualities (clarity, high gloss) and consistent uniformity (gauge of thickness).



## 3 mil Vacuum Pouches

THE BEST VALUE  
VACUUM BAGS

- » Stronger, thicker seals
- » More durable - better product protection during transport and handling
- » Simply superior

AS LOW AS  
**\$28.<sup>67</sup>**

Item #	Size (in)	Qty. / Case	Price / Case	SALE PRICE
120138	4 x 11	2,000	\$57.36	\$51.62
120201	5 x 7	1,500	\$34.03	\$30.63
120203	6 x 8	1,000	\$31.85	\$28.67
120205	6 x 10	1,000	\$36.29	\$32.66
120206	6 x 12	1,000	\$44.23	\$39.81
120210	7 x 9	1,000	\$39.70	\$35.73
120211	7 x 11	1,000	\$47.64	\$42.87
120212	8 x 10	1,000	\$48.77	\$43.89
120213	8 x 12	1,000	\$58.98	\$53.08
120214	8 x 15	1,000	\$73.72	\$66.35
120216	10 x 12	1,000	\$73.72	\$66.35
120217	10 x 13	1,000	\$79.39	\$71.45
120218	10 x 15	1,000	\$91.87	\$82.68
120219	10 x 18	500	\$54.44	\$48.99
120228	12 x 18	500	\$65.78	\$59.20
120230	14 x 16	500	\$68.05	\$61.25

## 4 mil Vacuum Pouches

Item #	Size (in)	Qty. / Case	Price / Case	SALE PRICE
120303	6 x 8	1,000	\$55.92	\$50.33
120312	8 x 10	1,000	<del>\$85.08</del>	\$76.57
120313	8 x 12	1,000	<del>\$97.91</del>	\$88.12
120332	8 x 15	500	<del>\$61.63</del>	\$55.47
120318	10 x 15	1,000	<del>\$150.55</del>	\$135.50
120328	12 x 18	500	<del>\$102.81</del>	\$92.53

## 5 mil Vacuum Pouches

Item #	Size (in)	Qty. / Case	Price / Case	SALE PRICE
120407	6 x 10	600	\$56.49	\$50.84
120409	6 x 15	1,000	\$99.20	\$89.28
120412	8 x 10	1,000	\$129.88	\$116.89
120413	8 x 12	1,000	\$142.04	\$127.84
120415	8 x 15	1,000	\$176.91	\$159.22
120417	8 x 22	500	\$143.19	\$128.87
120448	10 x 14	1,000	\$210.42	\$189.38
120425	12 x 14	1,000	\$236.74	\$213.07
120646	24 x 36	250	\$404.37	\$363.93
120660	22.5 x 24	250	\$257.05	\$231.35

## 3 mil Boil-in-Bags\*

Item #	Size (in)	Qty. / Case	Price / Case	SALE PRICE
160812	8 x 12	1,000	\$120.11	\$108.10
160815	8 x 15	1,000	\$148.34	\$133.51
161012	10 x 12	1,000	\$147.83	\$133.05
161214	12 x 14	1,000	\$206.83	\$186.15
161218	12 x 18	500	\$133.66	\$120.29
161626	16 x 26	250	\$127.05	\$114.35

» Our 3 mil boil-in-bags are ideal for packaging convenience foods or sous vide dishes.

\* Maximum temperature: 239°F (115°C)

# SHRINK BAGS, SPECIALTY VACUUM POUCHES

Our tough, multi layered tubular shrink bags feature exceptional clarity, superior strength, and sealing performance. Designed to deliver ultimate protection while maximizing shelf life and maintaining a fresh product appearance, our shrink bags are ideal for food products such as boneless and bone in subprimals; portioned cuts of beef, pork, lamb, and veal; smoked and further processed meats and cheese.



Shrink Bags				
Item #	Size (in)	Qty. / Case	Price / Case	SALE PRICE
150612-200	6 x 12	2,500	<del>\$279.28</del>	\$251.35
150616-200	6 x 16	1,000	<del>\$136.03</del>	\$122.42
150814-200	8 x 14	1,000	<del>\$144.45</del>	\$130.01
150820-200	8 x 20	1,000	<del>\$188.48</del>	\$169.63
150826-200	8 x 26	600	<del>\$145.32</del>	\$130.79
151012-200	10 x 12	1,500	<del>\$212.70</del>	\$191.43
151016-200	10 x 16	500	<del>\$93.91</del>	\$84.52
151020-200	10 x 20	500	<del>\$110.38</del>	\$99.35
151030-200	10 x 30	500	<del>\$162.99</del>	\$146.69
151216-200	12 x 16	1,000	<del>\$226.32</del>	\$203.68
151220-200	12 x 20	500	<del>\$141.19</del>	\$127.07
151224-200	12 x 24	500	<del>\$167.78</del>	\$151.00
151420-200	14 x 20	500	<del>\$166.17</del>	\$149.55
151432-200	14 x 32	300	<del>\$165.42</del>	\$148.88
151630-200	16 x 30	300	<del>\$179.18</del>	\$161.26

3 mil Zipper Vacuum Pouches (With Hanger Holes)				
Item #	Size (in)	Qty. / Case	Price / Case	SALE PRICE
120529	6 x 10	1,000	<del>\$100.33</del>	\$90.30
120537	6 x 12	1,000	<del>\$113.25</del>	\$101.93
120531	8 x 10	1,000	<del>\$133.78</del>	\$120.40
120533	8 x 12	1,000	<del>\$151.00</del>	\$135.90
120535	8 x 15	1,000	<del>\$169.39</del>	\$152.45
120542	10 x 15	500	<del>\$103.77</del>	\$93.39
120536	10 x 16	500	<del>\$110.69</del>	\$99.62
120538	12 x 14	500	<del>\$120.16</del>	\$108.14

» Designed with a hanger hole, our zipper vacuum pouches are perfect for retail display.



4 mil Gold/Clear Vacuum Pouches				
Item #	Size (in)	Qty. / Case	Price / Case	SALE PRICE
120109	6 x 8.5	2,000	<del>\$174.75</del>	\$157.28
120113	8 x 12	1,000	<del>\$164.77</del>	\$148.29
120118	10 x 15	1,000	<del>\$240.61</del>	\$216.55

» Our metallic gold foil vacuum pouches feature the high end look and feel of upscale packaging.



4 mil Black/Clear Vacuum Pouches				
Item #	Size (in)	Qty. / Case	Price / Case	SALE PRICE
120116	6 x 10	2,000	<del>\$181.26</del>	\$163.13
120117	8 x 10	1,000	<del>\$120.70</del>	<b>\$48.90</b>
120099	8 x 12	1,000	<del>\$144.84</del>	\$130.36

» Our metallic black foil vacuum pouches feature the high end look and feel of upscale packaging.

**ASK ABOUT  
CUSTOM SIZES  
GOLD OR BLACK**

**OVERSTOCK  
SALE!**



# PAPER, NETTING, BONE GUARDS, HAND PUMP INJECTOR

## WHITE FREEZER PAPER

- » Poly coated to keep moisture in
- » Protects against freezer burn from 6-12 months
- » FDA and USDA approved
- » Available in 15" or 18" widths
- » 1,000 – 1,100-ft



6 MONTH			
Item #	Description	Price Each	SALE PRICE
192028	15" x 1,100-ft.	\$42.95	\$38.66
192029	18" x 1,100-ft.	\$49.95	\$44.96
9 MONTH			
Item #	Description	Price Each	SALE PRICE
192035	18" x 1,000-ft.	\$52.95	\$47.66
12 MONTH			
Item #	Description	Price Each	SALE PRICE
192036	18" x 1,000-ft.	\$64.95	\$58.46

## SAFE HANDLING LABELS

- » White Label/Black Imprint

If you are not ready to make the jump to printed safe handling vacuum pouches, then our safe handling labels are the ideal, cost effective solution.



Item #	Size (in.)	Qty./Roll	Price/Roll	SALE PRICE
190100	1.5 x 2	1,000 labels	\$5.95	\$5.35

## HAND PUMP INJECTOR

Our Brine Pump is perfect for injecting brine, marinades and spice solutions into hams, bacon, turkey or any cuts of meat you desire. Continuous draw and screened hose end for quick and easy brining. If you inject cures and brines often this unit will pay for itself in time-savings alone.



Item #	Price/Each
536361	\$184.22

## BONE GUARD

Clear PVC Bone Guard covers the bone ends of your bone in steaks and hams to prevent the puncturing of packaging.



6 MIL CLEAR AND TRANSLUCENT BONE GUARD					
Item #	Size	Qty./Case	Rolls/Case	Price/Case	SALE PRICE
140017	4.5" x 5" x 650-ft. (1,560 sheets)	2,600-ft. per case	4	\$143.49	\$129.14
9 MIL CLEAR AND TRANSLUCENT BONE GUARD					
Item #	Size	Qty./Case	Rolls/Case	Price/Case	SALE PRICE
140010	4.5" x 5" x 200-ft. (480 sheets)	600-ft. per case	3	\$129.00	\$116.10
140035	9" x 650-ft. (roll)	650-ft. per case	1	\$156.80	\$141.12

## UltraSource NETTING

UltraSource netting provides a unique and attractive presentation and is excellent to use with many different cuts of meat. From boneless pork loins, boneless turkey breast, flank steak, and veal roasts to hams, prime rib, and large cured meats like supersotta and bologna. Our netting is sold in different diameters, all in lengths of 150 feet - measured under tension.

- » Ease of application
- » Speed - faster than hand-tying
- » Attractive appearance
- » Uniform cooking
- » Eliminates voids
- » Inner-basting



Item #	Stuffing Diameter	Square	Length	Price Each	SALE PRICE
145310	3"	10	150'	\$9.95	\$8.95
145314	4"	14	150'	\$11.95	\$10.75
145316	4.5"	16	150'	\$15.95	\$14.35
145318	5"	18	150'	\$16.95	\$15.25
145322	6"	22	150'	\$17.95	\$16.15
145326	7.5"	26	150'	\$18.95	\$17.05

# PAPER CUTTER AND TWINE



## 18" DOUBLE PAPER CUTTER

- » Holds 18" paper
- » Constructed of strong, tubular steel
- » Small footprint for floor or counter space
- » Easy loading, dispensing, and cutting

**NOTE:** Paper not included

Item #	Description	Price Each	SALE PRICE
501146	18" Double Cutter	\$109.95	\$98.96

## TWINE



Item #	Gallon Capacity	Price Each	SALE PRICE
449925	12 Ply, 3,200-ft.	\$8.99	\$8.09
449926	24 Ply, 1,600-ft.	\$8.99	\$8.09
449927	30 Ply, 1,280-ft.	\$8.99	\$8.09



## STANDARD PAPER CUTTERS

- » Dispenses smoothly
- » Double edge, spring loaded blade
- » Easy roll changing
- » Can also be mounted under counter or on a wall

**NOTE:** Paper not included

Item #	Description	Price Each	SALE PRICE
501140	15" Wide Powder Coated	\$29.95	\$26.96
501141	18" Wide Powder Coated	\$33.95	\$30.56
501142	18" Wide Stainless Steel	\$66.95	\$60.26

## DELUXE PAPER CUTTERS



- » Dispenses smoothly
- » Double edge, spring loaded blade
- » Easy roll changing
- » Sturdy, welded reinforced frame
- » Gray powder coated

**NOTE:** Paper not included

Item #	Description	Price Each	SALE PRICE
501143	15" Wide Deluxe Cutter	\$44.95	\$40.46
501144	18" Wide Deluxe Cutter	\$45.95	\$41.36

## TWINE HOLDER

- » Easily stores and dispenses 2-lb. and 3-lb. cones of twine
- » Suitable for table or over/under shelf mounting
- » Built in tension spring eliminates unraveling
- » Sturdy steel with light gray powder coat

**NOTE:** Twine not included



Item #	Description	Price/Roll	SALE PRICE
501044	Twine Holder	\$20.95	\$18.85

# STRING KNIT GLOVES

## SLOTTED THERMAL PAD

This double layered, machine washable terry cloth pad offers heat resistance for short term contact.

- » Hand slot for flexibility
- » Edge sewn to reduce fraying and extend usage
- » Double layers protect up to 450°F



Item #	Description	Price Each	SALE PRICE
441254	Thermal Hot Pad	\$2.75	\$1.95

## FRYER GLOVES



Perfect for deep fryer grease, broiler, and oil applications.

- » Suitable for temperatures up to 450°F
- » 18" length with sewn in storage loop
- » Prewashed 100% heavy cotton double jersey removable liner
- » Liner is machine washable
- » Not designed for open flame contact



Item #	Description	Price Each	SALE PRICE
441252	Fryer Glove, 18" Cuff	\$30.75	\$27.66
441253	Fryer Glove, Replacement Liner	\$11.75	\$10.56

## UltraSource STRING KNIT GLOVES

Economically priced, soft cotton blended with tough polyester provides seamless comfort and excellent thermal properties.

- » Overlocked cuff
- » Machine washable
- » One size fits all
- » Seamless, knitted construction



Item #	Size	Description	Price / Dozen	SALE PRICE
A 441068	Men/Women	Economy	\$3.39	\$2.95
B 441063	Men	Medium Weight	\$5.95	\$4.95

## GLOVE RACK

Keep organized and speed up drying time with this durable PVC coated steel rack from UltraSource.

- » Holds up to four pairs of various styles and sizes
- » Mounting screws included



Item #	Inside Dimensions	Price Each	SALE PRICE
446101	22" W x 14" H x 5.25" D	\$38.68	\$32.88



# UltraGlove® DISPOSABLE GLOVES

## VINYL DISPOSABLE UltraGlove® - POWDER FREE

Industrial grade and made from PVC vinyl, so those with latex allergies can rest assure they are latex free. These select quality vinyl disposable gloves feature excellent sensitivity in the palm and fingertips, as well as a smooth fit and feel. They are powder free, so when creating a seal or working with food, you won't have to worry about messy powder residue. Vinyl UltraGloves are cost effective and offer appropriate tear and puncture resistance for many food preparation and processing applications.

Vinyl UltraGloves are highly resistant to acids, fats, and alcohols and also have superior antistatic properties.

- » Premium quality vinyl
- » Powder free
- » Clear
- » Rolled cuff
- » Ambidextrous
- » Industrial grade
- » Excellent resistance to acids, fats, and alcohols
- » Superior antistatic properties
- » S, M, L, XL



Item #	Size	Price / Box of 100	SALE PRICE
441170-S	Small	\$3.95	\$2.57
441170-M	Medium	\$3.95	\$2.57
441170-L	Large	\$3.95	\$2.57
441170-XL	Extra Large	\$3.95	\$2.57

## BLUE NITRILE DISPOSABLE UltraGlove® - POWDER FREE

Industrial grade disposable glove with micro textured grip and excellent chemical resistance. These gloves are powder free to avoid possible contamination or powdery residues. The soft and pliable glove also features a micro-roughened texture for a non-slip grip in wet and dry conditions. UltraGloves feature excellent protection against many common and specialty chemicals.

Nitrile gloves are more puncture and abrasion resistant than vinyl or latex, while offering superior resistance to animal fats, acids, and other caustic material.

- » High quality nitrile
- » No natural latex components
- » Ambidextrous
- » 4 mil thick
- » Powder free
- » Beaded, rolled cuff
- » Textured finish for better grip
- » Industrial grade
- » S, M, L, XL, 2XL



Item #	Size	Price / Box of 100	SALE PRICE
441220-S	Small	\$6.95	\$5.21
441220-M	Medium	\$6.95	\$5.21
441220-L	Large	\$6.95	\$5.21
441220-XL	Extra Large	\$6.95	\$5.21
441220-2XL	2 Extra Large	\$6.95	\$5.21

# CUT RESISTANT GLOVES

## CUT RESISTANT UltraGlove®

Ambidextrous glove is constructed from high performance fibers and stainless steel to give an extra margin of safety with extra dexterity for the wearer.



- US 13**
- » 13 Gauge Light Weight
  - » Rated ANSI Level A5

Item #	Size	Price Each	SALE PRICE
441000-S	Small	\$7.75	\$6.96
441000-M	Medium	\$7.75	\$6.96
441000-L	Large	\$7.75	\$6.96
441000-XL	Extra Large	\$7.75	\$6.96

## PREMIUM CUT RESISTANT UltraGlove®

Premium ambidextrous blue glove offers dexterity of lighter gauge glove; but protection of heavier gauge.



- US 10P**
- » 10 Gauge Medium Weight
  - » Rated ANSI Level A6
- 

Item #	Size	Price Each	SALE PRICE
441025-S	Small	\$9.75	\$8.76
441025-M	Medium	\$9.75	\$8.76
441025-L	Large	\$9.75	\$8.76
441025-XL	Extra Large	\$9.75	\$8.76

## WRIST LENGTH CUFF WITH SEWN IN STRAP

- » Fully adjustable snap closure
- » Side slit for quick on and off



Item #	Size	Price Each
441030-S	Small	\$69.95
441030-M	Medium	\$69.95
441030-L	Large	\$69.95
441030-XL	Extra Large	\$69.95

## WRIST LENGTH CUFF WITH REPLACEABLE STRAP

- » Fully adjustable buckle closure



Item #	Size	Price Each
441040-S	Small	\$74.95
441040-M	Medium	\$74.95
441040-L	Large	\$74.95
441040-XL	Extra Large	\$74.95

## EXTENDED LENGTH CUFF WITH TWO REPLACEABLE STRAPS

- » Fully adjustable buckle closure



Item #	Size	Price Each
441050-S	Small	\$87.95
441050-M	Medium	\$87.95
441050-L	Large	\$87.95
441050-XL	Extra Large	\$87.95

Full protection, five finger ambidextrous gloves feature interlocking stainless steel mesh protecting user hands from severe injury.

# COATS & SMOCKS

## WHITE SMOCKS/LAB COATS

Our 7 oz. polyester/cotton twill lab coats are full cut for maximum comfort. Stitched with high quality 100% spun polyester thread.



- » 7 oz. 65/35 polyester/cotton twill
- » Heavy duty nickel plated brass dome snaps
- » Overlocked edges
- » Safety stitched seams



## THREE POCKET COAT

**NOTE:** One pocket inside top and two outside bottom

Item #	Size	Price / Each	SALE PRICE
460010-S	Small	\$23.50	\$21.15
460010-M	Medium	\$23.50	\$21.15
460010-L	Large	\$23.50	\$21.15
460010-XL	Extra Large	\$23.50	\$21.15
460010-2XL	2-Extra Large	\$30.77	\$27.69
460010-3XL	3-Extra Large	\$33.65	\$30.29

## NO POCKET COAT

Item #	Size	Price / Each	SALE PRICE
460020-S	Small	\$23.50	\$21.15
460020-M	Medium	\$23.50	\$21.15
460020-L	Large	\$23.50	\$21.15
460020-XL	Extra Large	\$23.50	\$21.15
460020-2XL	2-Extra Large	\$30.77	\$27.69
460020-3XL	3-Extra Large	\$33.65	\$30.29



## WRAP AROUND SMOCKS

- » Long ties with pass through side vents
- » 3/4 length sleeves
- » One inside top pocket and two outside bottom

Item #	Size	Price / Each	SALE PRICE
460000-S	Small	\$26.95	\$24.25
460000-M	Medium	\$26.95	\$24.25
460000-L	Large	\$26.95	\$24.25
460000-XL	Extra Large	\$26.95	\$24.25
460000-2XL	2-Extra Large	\$29.95	\$26.95

## COLOR SMOCKS/LAB COATS

Our 7 oz. polyester/cotton twill lab coats are full cut for maximum comfort. Stitched with high quality 100% spun polyester thread.

- » 7 oz. 65/35 polyester/cotton twill
- » Heavy duty nickel plated brass dome snaps
- » Overlocked edges
- » Safety stitched seams

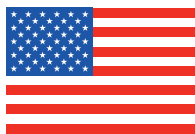

**NOTE:** One pocket inside top and two outside bottom

NAVY ITEM #	RED ITEM #	BLACK ITEM #	Size	Price / Each
460016-S	460013-S	460014-S	Small	\$23.50
460016-M	460013-M	460014-M	Medium	\$23.50
460016-L	460013-L	460014-L	Large	\$23.50
460016-XL	460013-XL	460014-XL	Extra Large	\$23.50
460016-2XL	460013-2XL	460014-2XL	2-Extra Large	\$25.50
460016-3XL	460013-3XL	460014-3XL	3-Extra Large	\$27.50



**DON'T FORGET  
ULTRA  
LAUNDRY SOAP  
CALL TODAY!**



Item #	SALE PRICE
501311	\$13.46

# APPAREL

## NITRILE HEAVY DUTY APRON

- » Double coated for durability and waterproofing
- » Neck strap has reinforced buckle grommet for optimal comfort
- » 24 mil thick / 27 oz. material
- » 35" W x 48" L



APRON COLOR SELECTIONS

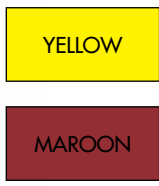

Item #	Description	Price / Each	SALE PRICE
450090	Yellow	\$19.95	\$17.96
450091	Maroon	\$19.95	\$17.96

## HYCAR APRONS

Designed for use when in contact with animal fats and greases in cold conditions.

- » 36" W x 48" L



APRON COLOR SELECTIONS

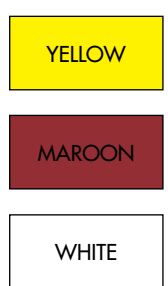

### MEDIUM WEIGHT

Item #	Description	Price / Each	SALE PRICE
450081	Maroon	\$13.50	\$12.15
450083	White	\$13.50	\$12.15
450085	Yellow	\$12.25	\$11.07

### HEAVY WEIGHT

Item #	Description	Price / Each	SALE PRICE
450080	Maroon	\$13.50	\$12.15
450082	White	\$13.50	\$12.15
450084	Yellow	\$13.50	\$12.15

### HEAVY WEIGHT WITH BELLY PATCH

Item #	Description	Price / Each	SALE PRICE
450086	Yellow	\$18.95	\$17.06

## POLYETHYLENE APRONS

These 28" W x 46" L polyethylene aprons are low cost, and disposable for light duty applications.



Item #	Description	Price / Case of 1000	SALE PRICE
450010	1 mil Blue	\$54.70	\$49.23
450011	1 mil White	\$65.23	\$58.71
450015	1.5 mil Embossed White	\$77.75	\$69.98

## 6 MIL POLYURETHANE APRONS

- » Comfortable and lightweight
- » Most popular Top Dog polyurethane apron



APRON COLOR SELECTIONS

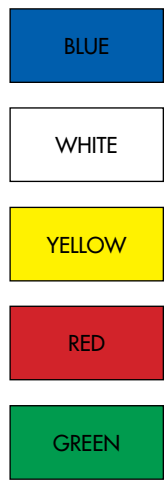

MACHINE WASHABLE & DRYABLE

Item #	Color	Price / Each	SALE PRICE
450129	Blue	\$9.95	\$9.45
450130	White	\$9.95	\$9.45
450131	Yellow	\$9.95	\$9.45
450132	Red	\$9.95	\$9.45
450133	Green	\$9.95	\$9.45

## 8 MIL POLYURETHANE APRONS

- » Adjustable with plastic buckle for great fit
- » 8 mil thickness for extra protection and durability
- » Available in white, blue, or yellow



APRON COLOR SELECTIONS

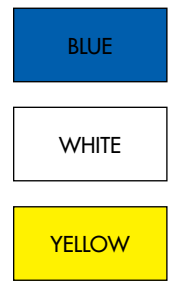

MACHINE WASHABLE & DRYABLE

Item #	Color	Price / Each	SALE PRICE
450101	White	\$14.95	\$13.45
450102	Blue	\$14.95	\$13.45
450103	Yellow	\$14.95	\$13.45

# DISPOSABLE ITEMS

## DISPOSABLE SHOE COVERS

- » 100% blue polypropylene
- » White tread coating for traction
- » Snug elastic fit around ankle



Item #	Color	Size	Price Case of 300	SALE PRICE
440089-L	Blue	Large	<del>\$32.95</del>	\$29.66
440089-XL	Blue	Extra Large	<del>\$34.95</del>	\$31.46

## SPUNBOUND HOOD

Constructed of latex free spunbound polypropylene.



Item #	Description	Pack of 100	SALE PRICE
444065	Large	\$10.95	\$9.90
444064	Extra Large	\$10.95	\$9.90
444066	<b>LARGE BLUE</b>	\$10.95	\$9.90

## BOUFFANT CAPS

Constructed of latex free spunbound polypropylene.



WHITE			
Item #	Size	Price / Bag of 100	SALE PRICE
444010	19"	\$3.95	\$2.95
444011	21"	\$4.49	\$3.49
444012	24"	\$4.95	\$3.95
444013	28"	\$5.49	\$4.49
LIGHT BLUE			
Item #	Size	Price / Bag of 100	SALE PRICE
444020	19"	\$4.25	\$3.25
444021	21"	\$4.75	\$3.75
444022	24"	\$5.45	\$4.45
444023	28"	\$5.95	\$4.95
RED			
Item #	Size	Price / Bag of 100	SALE PRICE
444060	21"	\$4.75	\$3.75
GREEN			
Item #	Size	Price / Bag of 100	SALE PRICE
444061	21"	\$4.75	\$3.75
NAVY BLUE			
Item #	Size	Price / Bag of 100	SALE PRICE
444062	21"	\$4.75	\$3.75

NOTE: Color bars are representative, not actual material color

## DISPOSABLE LAB COATS

- » Lightweight 100% white spunbound polypropylene
- » Elastic wrists
- » Plastic snap closure



Item #	Size	Price Case of 30	SALE PRICE
450033-S	Small	<del>\$39.95</del>	\$35.96
450033-M	Medium	<del>\$39.95</del>	\$35.96
450033-L	Large	<del>\$39.95</del>	\$35.96
450033-XL	Extra Large	<del>\$39.95</del>	\$35.96
450033-2XL	2-Extra Large	<del>\$39.95</del>	\$35.96

## DISPOSABLE PolyWear™ GOWN

- » Constructed from smooth polyethylene material
- » Thumb holes hold sleeves in place
- » Tear away shoulder for easy removal and disposal
- » Other colors available



Item #	Size	Qty. / Case	Price	SALE PRICE
450060	45"	100	<del>\$58.95</del>	\$53.06
450063	49"	100	<del>\$58.95</del>	\$53.06
450066	55"	75	<del>\$64.95</del>	\$58.46

## DISPOSABLE ITEMS DISPENSER

- » Holds bagged, boxed, or pleated styles
- » Wire dispenser mounts on wall or countertop



Item #	Dimensions	Price	SALE PRICE
445420	6.5" H x 12.25" W x 5" D	\$41.84	\$37.66

# UltraBoots™ HIGH PERFORMANCE POLYURETHANE BOOTS

## COWBOY CUT |

### KEEPS WARMTH IN |

Polyurethane insulates and remains flexible in cold temperatures helping keep feet warm and comfortable.

### FLEXIBLE |

Three flex points for greater range of motion in performing tasks throughout the day.

### ANKLE PROTECTION |

Built in cushion for ankle protection from low impacts.

### ULTIMATE COMFORT |

Thick, shock absorbent soles and premium form fitting insoles provide cushion to keep feet feeling refreshed longer.

### SLIP-FREE |

Heavy duty soles with deep and wide treads give better traction in areas with fats, proteins and liquids.

### QUALITY MATERIAL |

Polyurethane lasts 3x longer than PVC boots saving you money and time.

### PREMIUM PROTECTION |

Composite safety toe for foot protection meets ASTM standards and helps insulate for warmth while protecting your toes.

# COMFORT MEETS PERFORMANCE

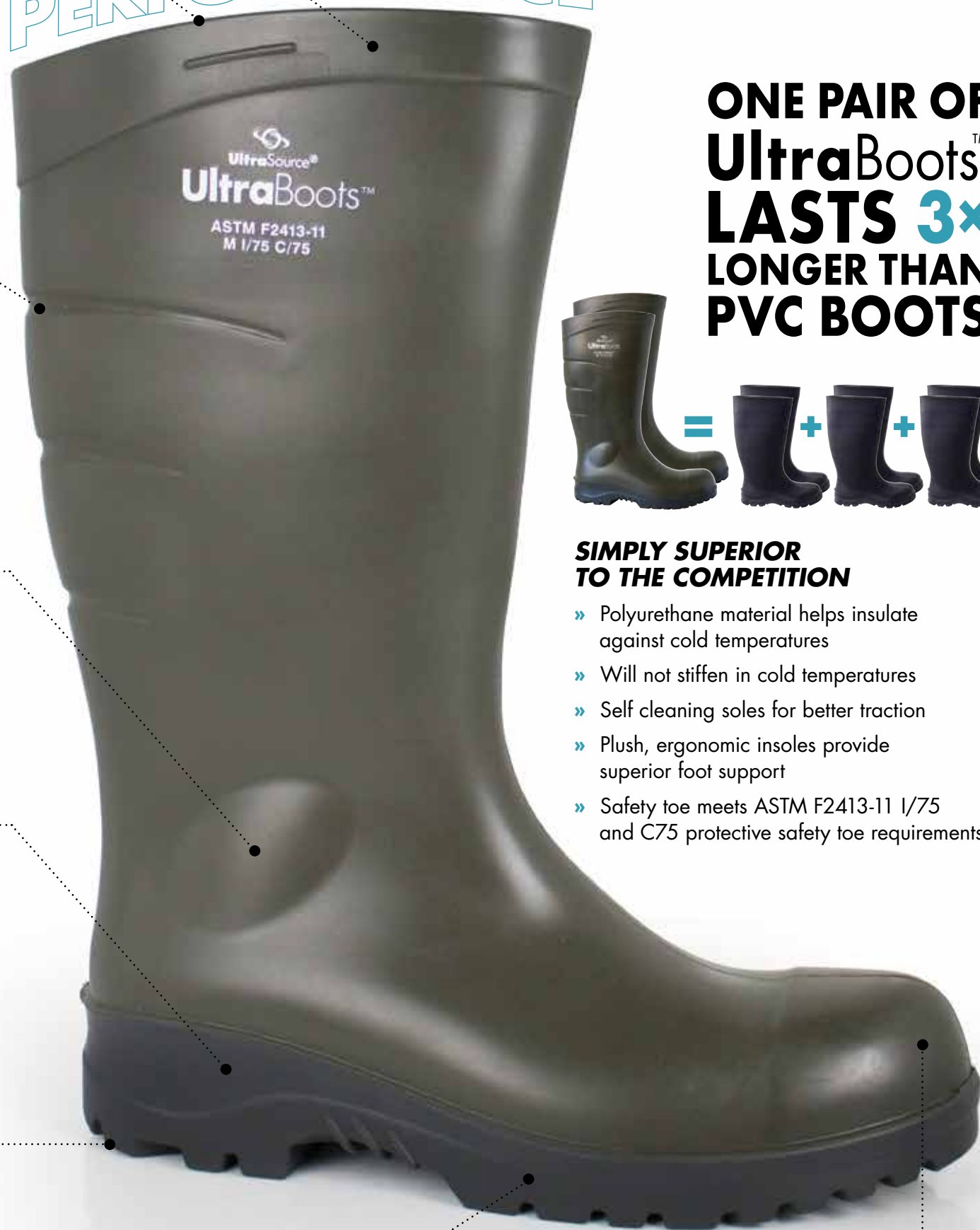

## ONE PAIR OF UltraBoots™ LASTS 3x LONGER THAN PVC BOOTS



### SIMPLY SUPERIOR TO THE COMPETITION

- » Polyurethane material helps insulate against cold temperatures
- » Will not stiffen in cold temperatures
- » Self cleaning soles for better traction
- » Plush, ergonomic insoles provide superior foot support
- » Safety toe meets ASTM F2413-11 1/75 and C75 protective safety toe requirements

# UltraBoots™ & INSOLES



GREEN ITEM#	YELLOW ITEM #	WHITE ITEM #	BLUE ITEM #	Size	Price/Pair	SALE PRICE
440015-5	440016-5	440017-5	440018-5	5	\$67.95	\$59.95
440015-6	440016-6	440017-6	440018-6	6	\$67.95	\$59.95
440015-7	440016-7	440017-7	440018-7	7	\$67.95	\$59.95
440015-8	440016-8	440017-8	440018-8	8	\$67.95	\$59.95
440015-9	440016-9	440017-9	440018-9	9	\$67.95	\$59.95
440015-10	440016-10	440017-10	440018-10	10	\$67.95	\$59.95
440015-11	440016-11	440017-11	440018-11	11	\$67.95	\$59.95
440015-12	440016-12	440017-12	440018-12	12	\$67.95	\$59.95
440015-13	440016-13	440017-13	440018-13	13	\$67.95	\$59.95
440015-14	440016-14	440017-14	440018-14	14	\$67.95	\$59.95
440015-15	440016-15	440017-15	440018-15	15	\$67.95	\$59.95

## COMFORT INSOLES

- » Compatible with dress, casual, and athletic shoes, boots, and even custom orthodontics
- » Heel-to-toe support and increased shock absorption helps prevent tired feet
- » 4-way Stretch Fabric with Silpure Antimicrobial helps prevent blisters while controlling odor
- » Hand washable, air dry
- » **FITTING FOR HALF SIZES:** order the next size down. For example, if you normally wear size 10.5, order a size 10

## HEAVY DUTY POLYSORB INSOLES

- » 4-Way Stretch Fabric with Silpure Antimicrobial helps prevent blisters while controlling odor
- » SBR Forefoot Pad provides superior cushioning and energy return for people on their feet all day
- » SpenCore Material a 5/32" layer of shock/impact-absorbing gel provide all-day comfort and cushioning
- » Heel-strike pad provides extra cushioning and shock absorption in the heel

## TRIPLE DENSITY GEL INSOLES

- » TPR Comfort Gel thermoplastic rubber combines superior cushioning and energy return for ultimate comfort
- » Metatarsal Arch Support relieves pressure from the ball-of-foot
- » Top Cloth with Silpure Antimicrobial helps eliminate odor causing bacteria and reduces friction
- » Stability Cradle supports the arch and heel for greater comfort



Item #	Size	Price/Pair	SALE PRICE
440127-S	6/7	\$8.95	\$8.06
440127-M	8/9	\$8.95	\$8.06
440127-L	10/11	\$8.95	\$8.06
440127-XL	12/13	\$8.95	\$8.06
440127-XXL	14/15	\$8.95	\$8.06



Item #	Size	Price/Pair	SALE PRICE
440129-S	6/7	\$14.95	\$11.11
440129-M	8/9	\$14.95	\$13.46
440129-L	10/11	\$14.95	\$13.46
440129-XL	12/13	\$14.95	\$13.46
440129-XXL	14/15	\$14.95	\$8.33



Item #	Size	Price/Pair	SALE PRICE
440128-S	6/7	\$9.95	\$8.33
440128-M	8/9	\$9.95	\$8.95
440128-L	10/11	\$9.95	\$8.33
440128-XL	12/13	\$9.95	\$8.33
440128-XXL	14/15	\$9.95	\$8.95

# BOOTS & ACCESSORIES



## DURAPRO BLUE

- » Moderate chemical resistant PVC
- » Urethane contoured insole with reinforced arch for all day comfort
- » Pull tabs for easy donning
- » Steel toe

Item #	Size	Price/Pair	SALE PRICE
440037-5	5	<del>\$34.90</del>	\$31.41
440037-6	6	<del>\$34.90</del>	\$31.41
440037-7	7	<del>\$34.90</del>	\$31.41
440037-8	8	<del>\$34.90</del>	\$31.41
440037-9	9	<del>\$34.90</del>	\$31.41
440037-10	10	<del>\$34.90</del>	\$31.41
440037-11	11	<del>\$34.90</del>	\$31.41
440037-12	12	<del>\$34.90</del>	\$31.41
440037-13	13	<del>\$34.90</del>	\$31.41
440037-14	14	<del>\$34.90</del>	\$31.41
440037-15	15	<del>\$34.90</del>	\$31.41



## 16" GOLIATH BOOTS

- » 16" injection molded seamless construction
- » Built in steel shank for firm arch support
- » Heel kick off lugs for easy on/off
- » Good protection against animal fats, especially red meats and proteins
- » Steel toe

Item #	Size	Price/Pair	SALE PRICE
440050-6	6	<del>\$26.50</del>	\$25.18
440050-7	7	<del>\$26.50</del>	\$25.18
440050-8	8	<del>\$26.50</del>	\$25.18
440050-9	9	<del>\$26.50</del>	\$25.18
440050-10	10	<del>\$25.50</del>	\$25.18
440050-11	11	<del>\$25.50</del>	\$25.18
440050-12	12	<del>\$25.50</del>	\$25.18
440050-13	13	<del>\$25.50</del>	\$25.18
440050-14	14	<del>\$25.50</del>	\$25.18
440050-15	15	<del>\$25.50</del>	\$25.18



## DUNLOP CHESAPEAKE ECONOMY PVC BOOTS

- » 25% lighter than classic PVC boots
- » Sloped comfort rim
- » Energy absorbing Bay-Loc outsole
- » ASTM certified safety toe

Item #	Size	Price/Pair	SALE PRICE
440008-5	5	<del>\$16.95</del>	\$15.99
440008-6	6	<del>\$16.95</del>	\$15.99
440008-7	7	<del>\$16.95</del>	\$15.99
440008-8	8	<del>\$16.95</del>	\$15.99
440008-9	9	<del>\$16.95</del>	\$15.99
440008-10	10	<del>\$16.95</del>	\$15.99
440008-11	11	<del>\$16.95</del>	\$15.99
440008-12	12	<del>\$16.95</del>	\$15.99
440008-13	13	<del>\$16.95</del>	\$15.99
440008-14	14	<del>\$16.95</del>	\$15.99
440008-15	15	<del>\$16.95</del>	\$15.99



## ECONOMY BOOTS

- » Lug sole design offers easy cleanup and slip resistance
- » Cut off bands for custom fit
- » Heel kick off lugs for easy on/off
- » Steel toe

Item #	Size	Price/Pair	SALE PRICE
444106-6	6	<del>\$16.25</del>	\$14.63
444106-7	7	<del>\$16.25</del>	\$14.63
444106-8	8	<del>\$16.25</del>	\$14.63
444106-9	9	<del>\$16.25</del>	\$14.63
444106-10	10	<del>\$16.25</del>	\$14.63
444106-11	11	<del>\$16.25</del>	\$14.63
444106-12	12	<del>\$16.25</del>	\$14.63
444106-13	13	<del>\$16.25</del>	\$14.63
444106-14	14	<del>\$16.25</del>	\$14.63
444106-15	15	<del>\$16.25</del>	\$14.63



## BLACK PVC OVERSHOES

- » Fits over most work shoes and boots
- » Flexible even in cold environments
- » Outsole offers slip resistance and self-cleans
- » Kick-off lug aids in the easy slip on and off

Item #	Size	Price/Pair
440095-XS	6	\$17.95
440095-S	7	\$17.95
440095-M	8	\$17.95
440095-L	9	\$17.95
440095-XL	10	\$17.95
440095-2XL	11	\$17.95
440095-3XL	12	\$17.95



## BOOT RACK

Stay organized and speed up drying time with this durable PVC coated steel rack from UltraSource.

- » Holds up to four pairs of various styles and sizes
- » Green PVC coating withstands bleaches, common acids, and solvents found in industrial areas

Item #	Price
446100	\$38.95



# BOOT BRUSH, DISINFECTANT MAT, GRATE REMOVAL

## BOOT & SHOE BRUSH

- » Bristles and blocks are made from FDA compliant resins
- » For additional stability, chrome frame can be bolted to the floor
- » Flip brushes up to use steel scraper for tough, stuck on debris



Item #	Color	Price/Each	SALE PRICE
509419	Blue	\$73.95	\$68.95
<b>REPLACEMENT BRUSH</b>			
Item #	Color	Price/Each	SALE PRICE
509422	Blue	\$12.95	\$11.65

## DISINFECTANT BOOT MAT

- » 2" yellow safety wall holds up to 22 quarts of liquid for hygienic cleansing
- » Deep profile allows maximum coverage of the sole, sides, and arch area of boot



Item #	Description	Price/Pair	SALE PRICE
446010	32" x 39" Disinfectant Boot Mat	\$108.95	\$103.50

## FLOOR DRAIN GRATE REMOVAL TOOL

- » Convenient, sanitary way to remove floor drain covers
- » Easy to use, simply insert into drain and twist to remove drain cover and drain basket
- » Plastic handles allow for a secure grip
- » One-piece construction for easy sanitizing
- » 304 Stainless Steel



Item #	Price Each	SALE PRICE
509099	\$28.50	\$25.65

## ULTRA FAT DISSOLVER



- » Breaks down fat and grease
- » Keeps drains free flowing
- » Reduces grease trap service
- » Max of 4 per order
- » **CAPACITY:** one gallon

Item #	Price Each	SALE PRICE
501312	\$14.95	\$13.45



**CHECK OUT OUR  
DRAIN BRUSHES  
& SCRUB BRUSHES**

**PAGE 19**

# WHITE MINERAL OIL, CLEANERS



501334



501333



501332



501331



501390



501330

## WHITE MINERAL OIL

UltraPro Food Grade White Oils are colorless, odorless, and tasteless mixtures of saturated paraffinic and naphthenic hydrocarbons. Our food grade white oils are chemically and biologically stable and do not support bacterial growth. UltraPro Food Grade White Oils contain Vitamin E, a natural antioxidant to protect quality during handling and storage.

- » Colorless, odorless, and tasteless
- » Vitamin E, a natural antioxidant to protect quality
- » Chemically and biologically stable
- » Also available in 55 gal. drum

Item #	Description	Price	SALE PRICE
501330	White Mineral Oil - 4 oz.	<del>\$3.30</del>	\$2.97
501390	White Mineral Oil - 12 oz.	<del>\$6.95</del>	\$6.25
501331	White Mineral Oil - 16 oz.	<del>\$5.25</del>	\$4.73
501332	White Mineral Oil - 32 oz.	<del>\$6.50</del>	\$5.85
501333	White Mineral Oil - 1 gal.	<del>\$19.50</del>	\$17.55
501334	White Mineral Oil - 5 gal.	<del>\$89.00</del>	\$80.10
501335	White Mineral Oil - 55 gal.	<del>\$785.00</del>	\$706.50

## TOTAL SOLUTIONS



Item #	Price Each	SALE PRICE
501300	\$10.75	\$9.68

### SURFACE SANITIZING WIPES

- » No rinse sanitizer for food and nonfood contact surfaces
- » Tested in accordance with AOAC methods
- » Meets EPA requirements for sanitizing previously cleaned food contact surfaces
- » **CAPACITY:** 100 Count



Item #	Price Each	SALE PRICE
501306	\$5.95	\$5.36

### NSF D2 SURFACE SANITIZING SPRAY

- » Kills 99.9% of bacteria within a minute
- » No rinse formula
- » No mixing required
- » **CAPACITY:** One Quart



Item #	Price Each	SALE PRICE
501354	\$17.95	\$16.95

### ENVIRO-TERRA HD

- » Highly-concentrated safe acid replacement
- » pH is less than 1, but safe to users
- » Dissolves hard water build-up
- » Removes limescale and corrosion
- » Biodegradable, non-flammable
- » **CAPACITY:** One Gallon



**CASE OF 4 GALLON BOTTLES**

Item #	Price Case	SALE PRICE
501352-CS	\$55.82	\$50.24

### SUPER-SOLV #1

- » 12% Butyl
- » Removes grease, grime, and dirt from all water-safe hard surfaces
- » Perfect for use in kitchen, bathroom, industrial, institutional, commercial, and automotive settings
- » NSF Certified: A4
- » Max of 2 cases per order
- » 4 one gallon bottles per case

**NOTE:** Special Shipping Required  
No Free Shipping

# CLEANING PRODUCTS

## CLEANERS & DEGREASERS



Item #	Price Each	SALE PRICE
501311	\$14.95	\$13.46

### ULTRA LAUNDRY SOAP

- » Institutional strength for highly soiled items
- » Works with all types of fabric in hard or soft water at all water temperatures
- » Contains no phosphates and is biodegradable
- » Light lilac fragrance
- » **CAPACITY:** One Gallon



Item #	Price Each	SALE PRICE
501327	\$13.95	\$12.56

### ENVIRO-CAUSTIC SMOKEHOUSE CLEANER

- » Safe-caustic smokehouse cleaner
- » pH of greater than 12.5 but non-corrosive to skin
- » Mild odor
- » Biodegradable
- » Foaming formula clings to vertical and horizontal surfaces
- » Ships DOT non-hazardous
- » Pending NSF A8 approval
- » **CAPACITY:** One Gallon



Item #	Price Each	SALE PRICE
501378	\$8.95	\$8.06

### STAINLESS STEEL CLEANER SPRAY

Stainless Steel Cleaner aerosol uses a non-oily formula to remove smudges, soils, and stains from stainless steel surfaces. It also brightens and protects against water marks and corrosion.



Item #	Price Each	SALE PRICE
501312	\$14.95	\$13.45

### ULTRA FAT DISSOLVER

- » Breaks down fat and grease
- » Keeps drains free flowing
- » Reduces grease trap service
- » Max of 4 per order
- » **CAPACITY:** One Gallon

**NOTE:** Special Shipping Required  
No Free Shipping

## TOTAL SOLUTIONS

## DENATURANT



Item #	Case Price	SALE PRICE
501301-CS	\$64.00	\$58.00

### NSF D2 VANQUISH

- » Broad spectrum disinfectant, sanitizer, Virucide, and mildewstat
- » Active in hard water up to 400ppm
- » Sanitizes food contact surfaces
- » Max of 4 per order
- » **CAPACITY:** One Gallon

**NOTE:** Special Shipping Required  
No Free Shipping



Item #	Price Each	SALE PRICE
501356	\$13.95	\$12.56

### LIVE MICRO™

- » Odor and waste eliminator
- » Destroys odors and waste at the source
- » Ideal for use on floors, walls, grease traps, and drains
- » Effective against surface odors, grease, and oils
- » **CAPACITY:** One Gallon



Item #	Color	Unit of Measure	Price/Each
501336	Charcote	Gallon	\$12.45
501357	Greenall	Gallon	\$16.45
501358	Blue	Gallon	\$16.45

### DENATURANT

- » Identifier for meat and poultry products that are intended for use other than human food

# BROOMS & BRUSHES

## DUO SWEEP® ANGLE BROOMS

- » Designed for extended use and superior performance with an ergonomic shape that prevents uneven wear
- » Includes 48" color coded, Self Locking Flex Tip™ fiberglass handle
- » Durable, sanitary polypropylene bristles



Item #	Color	Price Each	SALE PRICE
509183	Red	\$21.49	\$19.34
509184	Yellow	\$21.49	\$19.34
509185	White	\$21.49	\$19.34
509180	Blue	\$21.49	\$19.34
509182	Green	\$21.49	\$19.34

## UTILITY SCRUB BRUSHES

- » Block size is 3", handles are 8" or 20" long, and bristles are 1-5/8" long
- » Multiple trim angles on bristles for better surface cleaning
- » Available with pistol grips in popular 8" or 20" handle lengths
- » Ergonomically shaped handles offer superior comfort and feature eyelet for easy cleaning and storage
- » Bristles available in HACCP compliant red, white, or yellow



8" UTILITY SCRUB BRUSHES			
Item #	Color	Price Each	SALE PRICE
509214	Red	\$8.49	\$7.64
509215	White	\$8.49	\$7.64
509216	Yellow	\$8.49	\$7.64
509211	Blue	\$8.49	\$7.64
509213	Green	\$8.49	\$7.64
20" UTILITY SCRUB BRUSHES			
Item #	Color	Price Each	SALE PRICE
509224	Red	\$10.49	\$9.44
509225	White	\$10.49	\$9.44
509226	Yellow	\$10.49	\$9.44
509221	Blue	\$10.49	\$9.44
509223	Green	\$10.49	\$9.44

## DRAIN BRUSHES & HANDLES

- » Long lasting Polypropylene bristles and stand up to rugged use
- » Plastic handle (sold separately)
- » "USE FOR FLOOR DRAIN ONLY" is prominently imprinted in English and Spanish on the plastic drain handle (sold separately) to prevent contact with food and serving utensils
- » Special female threaded plastic handle accepts floor drain brushes only to prevent cross-contamination
- » BPA free



DRAIN BRUSHES				
Item #	Size	Color	Price Each	SALE PRICE
509290	3"	Black	\$16.24	\$14.62
509291	4"	Black	\$17.04	\$15.34
509292	5"	Black	\$17.77	\$15.99
509293	6"	Black	\$18.54	\$16.69
DRAIN BRUSH HANDLES				
Item #	Size	Color	Price Each	SALE PRICE
509294	36"	White	\$21.50	\$19.35
509295	48"	White	\$22.50	\$21.38

## VIKAN 10" SINGLE BLADE ULTRA HYGIENE BENCH SQUEEGEE



Vikan's one-piece, single-blade squeegee has an ultra-hygienic design that minimizes areas for water and food soils to collect. This seamless, one-piece construction is especially effective in areas requiring the highest level of hygiene. The soft and flexible rubber blade is ideal for removing water or food debris from floors and food contact surfaces. Hygiene squeegees are a good foundation for any HACCP or food safety program.

Item #	Color	Price Each	SALE PRICE
509159	Blue	\$19.95	\$17.95
509177	White	\$19.95	\$17.95

# BRUSHES, SQUEEGEES, SCOUR PADS

## ONE PIECE RUBBER SQUEEGEES

- » All plastic construction will not rust
- » Safe to use on uneven surfaces or delicate tile and marble floors
- » Helps prevent hazardous sparks when cleaning up flammable fluids



Item #	Description	Price Each	SALE PRICE
509123	20" Red, Rubber	<del>\$23.50</del>	\$21.15
509124	20" White, Rubber	<del>\$23.50</del>	\$21.15
509125	20" Yellow, Rubber	<del>\$23.50</del>	\$21.15
509120	20" Blue, Rubber	<del>\$23.50</del>	\$21.15
509122	20" Green, Rubber	<del>\$23.50</del>	\$21.15
509134	24" Red, Rubber	<del>\$27.50</del>	\$24.75
509135	24" White, Rubber	<del>\$27.50</del>	\$24.75
509136	24" Yellow, Rubber	<del>\$27.50</del>	\$24.75
509130	24" Blue, Rubber	<del>\$27.50</del>	\$24.75
509132	24" Green, Rubber	<del>\$27.50</del>	\$24.75

## BRUSH & BROOM HANDLES

- » 60" fiberglass handle
- » Self locking flex tip
- » 1" diameter with hanging cap

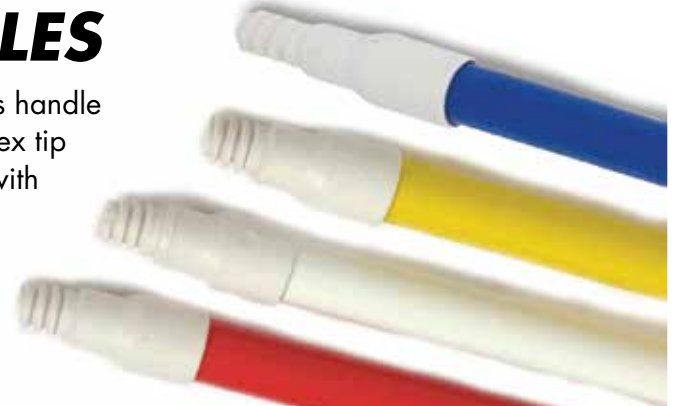

Item #	Color	Price Each	SALE PRICE
509104	Red	<del>\$13.49</del>	\$12.14
509106	White	<del>\$13.49</del>	\$12.14
509107	Yellow	<del>\$13.49</del>	\$12.14
509101	Blue	<del>\$13.49</del>	\$12.14
509103	Green	<del>\$13.49</del>	\$12.14

## HI LO SCRUB BRUSHES

- » Crimped bristles wash easily and prevent gathering of mold and mildew
- » Split shape is efficient for cleaning flat surfaces, under counters, around equipment, and along baseboards
- » Maximum cleaning at three different angles, 10" long plastic block
- » Base resins used to produce blocks and bristles are made of FDA approved materials
- » Handles sold separately (see at left)



Item #	Color	Price Each	SALE PRICE
509204	Red	<del>\$11.49</del>	\$10.34
509205	White	<del>\$11.49</del>	\$10.34
509206	Yellow	<del>\$11.49</del>	\$10.34
509201	Blue	<del>\$11.49</del>	\$10.34
509203	Green	<del>\$11.49</del>	\$10.34

## SCOUR PADS

- » General Purpose – green nylon blend, medium abrasive for general cleaning
- » Light Duty – white non-abrasive for delicate surfaces
- » Heavy Duty - green thick nylon blend, heavy duty abrasive for tough grime
- » All Purpose – maroon non-woven pad with abrasive grain and bonded with synthetic resin for removing rust and corrosion
- » 6" x 9"

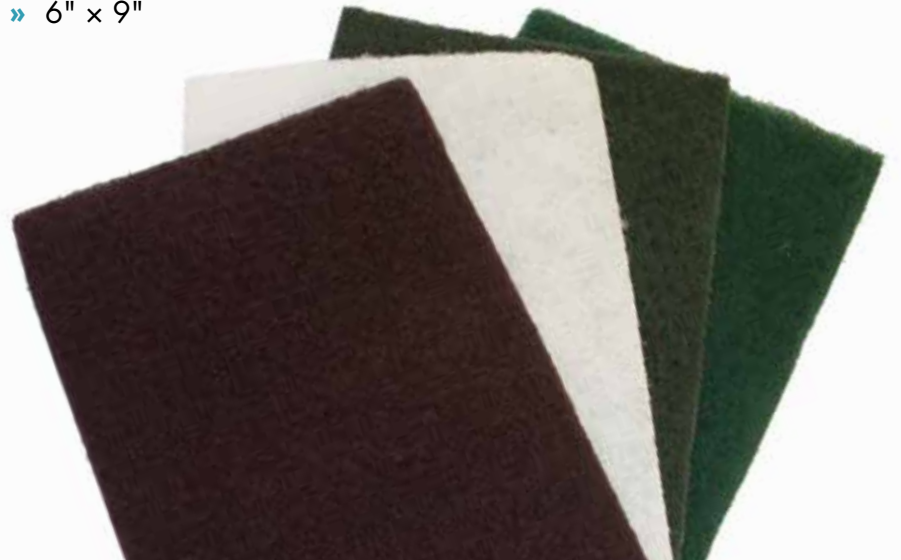

Item #	Description	Price / Pack of 10	SALE PRICE
501538	General Purpose	<del>\$4.05</del>	\$3.65
501542	Light Duty	<del>\$4.25</del>	\$3.88
501539	Heavy Duty	<del>\$7.15</del>	\$6.44
501540	All Purpose	<del>\$6.09</del>	\$5.48

# FOAMERS & SPRAYERS

## 2.11 GALLON MULTI COMPRESSION SPRAYER



- » Safety valve with depressurization option
- » Strong translucent tank with level indicator
- » Funnel incorporated into tank
- » Metal lever on trigger release valve
- » Base of tank can be used to wind the hose around it for storage
- » Carrying handle and straps for carrying over shoulder
- » **WORKING CAPACITY:** 2.11 GAL
- » **WEIGHT:** 4.25-lbs.

Item #	Capacity	Price/Each	SALE PRICE
501416	2.11 Gallon	<del>\$78.80</del>	<b>\$70.92</b>

## 1.06 GALLON MULTI COMPRESSION SPRAYER



- » Safety valve with depressurization option
- » Strong translucent tank with level indicator
- » Funnel incorporated into tank
- » Metal lever on trigger release valve
- » Filter in the lance
- » Base of tank can be used to wind the hose around it for storage
- » Carrying handle and straps for carrying over shoulder
- » **WORKING CAPACITY:** 1.06 GAL
- » **WEIGHT:** 3.23-lbs.

Item #	Capacity	Price/Each	SALE PRICE
501415	1.06 Gallon	<del>\$60.96</del>	<b>\$54.86</b>

## 3.37 GALLON MULTI COMPRESSION SPRAYER



- » Easy assembly and disassembly for cleaning and maintenance
- » Tank lid with anti-drip valve
- » Large opening with filter for easy filling and cleaning
- » Interior liquid agitator
- » Carrying handle and straps for carrying over shoulder
- » Supplied with adjustable cone spray nozzle
- » **WORKING CAPACITY:** 3.37 GAL
- » **WEIGHT:** 6.51-lbs.

Item #	Capacity	Price/Each	SALE PRICE
501418	3.37 Gallon	<del>\$137.60</del>	<b>\$123.84</b>



Item #	Description	Price Each	SALE PRICE
509435	Safety Orange	<del>\$96.95</del>	<b>\$87.26</b>

## PLASTIC SPRAY NOZZLE

- » Lightweight, durable, and corrosion resistant
- » 3/4" Type 316 stainless steel hose barb fitting
- » Rated at +185°F (85°C)
- » Maximum pressure of 100 PSI
- » Washers and O-rings are made from high temperature resistant Viton material



Item #	Capacity	Price	SALE PRICE
501406	96-oz.	<del>\$78.95</del>	<b>\$71.06</b>

## INDUSTRIAL FOAMER/DEGREASER

- » Foaming and degreaser lids included
- » Consistently mix solutions with the accompanying 15 colored metering tips
- » Handles water temperature to 180°F
- » Maximum 100 PSI water pressure
- » 3/4" GHT connection

Not suitable for food



Item #	Capacity	Price	SALE PRICE
501413	33-oz.	<del>\$29.41</del>	<b>\$26.47</b>

## 33oz. ALKALINE TRIGGER SPRAYER BLUE

- » Safety valve with depressurization option
- » Large opening for easy filling and cleaning
- » Ergonomic design
- » Strong translucent tank with level indicator
- » Protective sleeve for valve chamber
- » Easy assembly and taking apart for cleaning and maintenance, tool free
- » **WORKING CAPACITY:** 33 oz.
- » **WEIGHT:** 1.02-lbs.

# HOSES, ADAPTERS & NOZZLES



Item #	Description	Price	SALE PRICE
509024	High Pressure, 25' Blue, Non Marking	<del>\$85.95</del>	\$77.36
509025	High Pressure, 50' Blue, Non Marking	<del>\$124.95</del>	\$112.46

## HIGH PRESSURE HOSE

- » Reinforced with wire braid
- » For up to +170°F and 3,000 PSI use
- » 3/8" NPT connectors and bend restrictors on each end
- » One swivel and one straight fitting

## YELLOW HOT WATER 3/4" HOSE

- » Multiple textile cord for added strength
- » For -40°F to +212°F use
- » Garden hose couplings on each end
- » Insulators at each end to protect hands
- » Best resistance to oils and fats



**NOTE:** Not suitable for food

Item #	Description	Price Each	SALE PRICE
509012	25' Yellow Hot Water Hose	<del>\$116.95</del>	\$105.26
509013	50' Yellow Hot Water Hose	<del>\$194.95</del>	\$175.46



Item #	Description	Price	SALE PRICE
509014	25' General Purpose	<del>\$64.95</del>	\$58.46
509015	50' General Purpose	<del>\$94.95</del>	\$85.46

## GENERAL PURPOSE 3/4" HOSE

- » Synthetic high tensile textile cord
- » For -40°F to +200°F use
- » Garden hose couplings on each end



Item #	Description	Price Each	SALE PRICE
509010	25' White Hot Water Hose	<del>\$94.95</del>	\$85.45
509011	50' White Hot Water Hose	<del>\$157.95</del>	\$142.15

## WHITE NON MARKING HOT WATER 3/4" HOSE

- » Multiple textile cord for added strength
- » For -40°F to +212°F use
- » Garden hose couplings on each end
- » Cover is non marking

**NOTE:** Not suitable for food

## SWIVEL ADAPTER

- GHT** = Garden Hose Thread
- MGHT** = Male Garden Hose Thread
- FGHT** = Female Garden Hose Thread
- PT** = Pipe Thread



- » Check out our website [UltraSourceUSA.com](http://UltraSourceUSA.com) for our whole line of adapters

Item #	Description	Price	SALE PRICE
509002	3/4" FGHT x 3/4" FGHT	<del>\$7.95</del>	\$7.15



## JUNIOR BRONZE SPRAY NOZZLE

- » Weighs 50% less than the standard nozzle
- » Save water with a reduction in gallons used per minute (GPM)
- » Trigger controls a variable spray pattern

Item #	Adapter Style	Price Each	SALE PRICE
509033	Bronze, Black Junior, Swivel GHT	<del>\$74.95</del>	\$67.46
509433	Junior, Swivel BARB	<del>\$74.95</del>	\$67.46

## STANDARD BRONZE SPRAY NOZZLE



- » Industrial grade spray nozzles makes clean up a cinch
- » Heavy duty bronze and stainless steel construction holds up to tough working environments
- » Rubber cover is designed to withstand exposure to various chemicals and oils, in addition to harsh climates
- » Handles water up to 200°F and has a maximum pressure of 150 PSI
- » Swivel adapter included

Item #	Adapter Style	Price Each	SALE PRICE
509030	Bronze, Black, Swivel GHT	<del>\$88.95</del>	\$80.06
509430	Bronze, Black, Swivel BARB	<del>\$88.95</del>	\$80.06

## COLORED SPRAY NOZZLES

- » Handles water temperature to 180°
- » Maximum 100 PSI water pressure
- » 3/4" Female GHT connection



Item #	Color	Price Each	SALE PRICE
509480	Orange	<del>\$10.50</del>	\$9.45
509481	Black	<del>\$10.50</del>	\$9.45
509482	White	<del>\$10.50</del>	\$9.45
509483	Red	<del>\$10.50</del>	\$9.45
509484	Blue	<del>\$10.50</del>	\$9.45
509485	Green	<del>\$10.50</del>	\$9.45
509486	Yellow	<del>\$10.50</del>	\$9.45

## BONING KNIVES

SAFETY ORANGE

ANTIBACTERIAL HANDLES

- » High quality Molybdenum steel
- » Cryogenic treatment enhances performance and retains edge longer
- » Orange antibacterial textured handles
- » Front and rear bolsters protect against slippage

Item #	Size	Flex	Price / Each	SALE PRICE
449029	6" Curved	Semi-Flex	<del>\$9.39</del>	\$8.45
449030	5" Curved	Semi-Flex	<del>\$8.89</del>	\$8.00
449031	6" Curved	Stiff	<del>\$9.79</del>	\$8.81
449032	5" Curved	Stiff	<del>\$9.29</del>	\$8.36
449429	6" Curved	Flex	<del>\$9.09</del>	\$8.18
449430	5" Curved	Flex	<del>\$8.59</del>	\$7.73
Item #	Size	Flex	Price / Each	SALE PRICE
449426	6" Straight	Stiff	<del>\$9.49</del>	\$8.54
449427	5" Straight	Stiff	<del>\$8.89</del>	\$8.00
449428	6" Wide Straight	Stiff	<del>\$9.99</del>	\$8.99
449431	6" Narrow Straight	Flex	<del>\$9.09</del>	\$8.18

EXPERIENCE WHY SO MANY ARE SWITCHING TO ULTRAKNIVES. **UltraKnives ARE BETTER AND WE WILL PROVE IT!** CONTACT US TO GET YOUR OWN FREE KNIFE!



**GREAT VALUE!**

449429

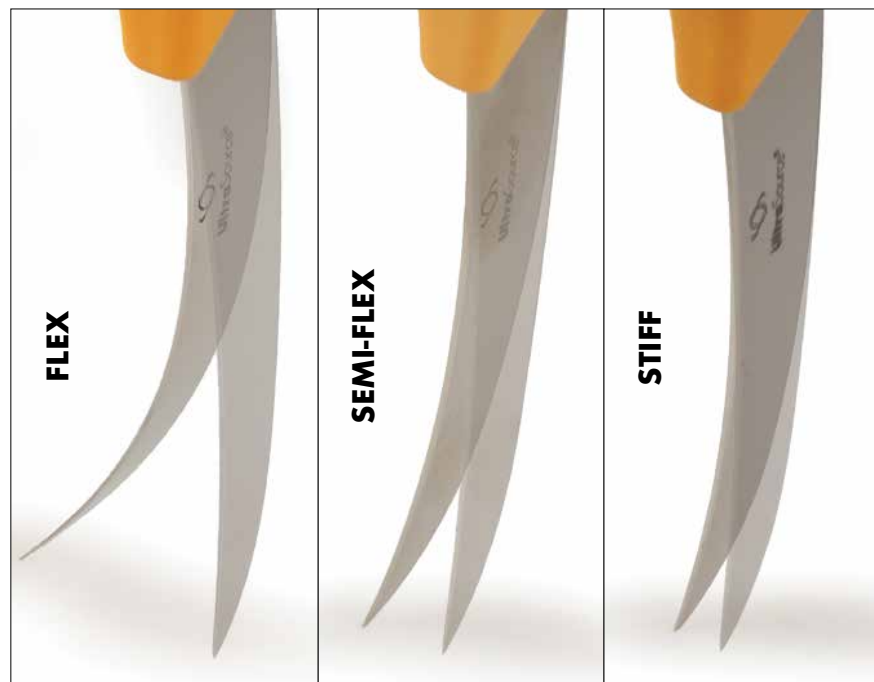

## BUTCHER KNIVES



449414

449413

449406

Item #	Size	Price / Each	SALE PRICE
449406	10" Straight	<del>\$19.29</del>	\$17.36
449413	10" Cimeter	<del>\$19.89</del>	\$17.90
449414	8" Fluted Breaking	<del>\$14.69</del>	\$13.22





# STEELS, SHARPENERS, HANDSAW

## BUTCHER STEEL

- » 10" tapered shaft
- » Ergonomic handles
- » Tough, break proof cores and resistant to wear surfaces
- » Realigns knife's edge to center
- » Keeps edges sharp, increasing the longevity of your knife investment
- » Easy to clean



Item #	Size	Price / Each	SALE PRICE
449998	10" Steel, Regular	<del>\$9.95</del>	\$8.96
449999	10" Steel, Polished	<del>\$9.95</del>	\$8.96

## PLASTIC INDUSTRIAL KNIFE SCABBARD

- » Two knife scabbard
- » Durable poly material
- » Dimensions: 5" x 9" or 5" x 14"
- » Great scabbard for butcher, boning, and other knives
- » Easy to clean



Item #	Size	Price / Each	SALE PRICE
449813	5" x 9" Two knife scabbard	<del>\$15.49</del>	\$13.94
449814	5" x 14" Two knife scabbard	<del>\$17.49</del>	\$15.74

## X-tra EDGE® KNIFE SHARPENING SYSTEM



Item #	Description	Price / Each	SALE PRICE
420100	X-tra EDGE Sharpener	<del>\$949.00</del>	\$854.10

### REPLACEMENT WHEELS

Item #	Description	Price / Each	SALE PRICE
420103	Sharpening Wheels	<del>\$39.95</del>	\$35.95
420104	Honing Wheels	<del>\$39.95</del>	\$35.95

## SCABBARD CHAIN

- » 48" Chain belt for knife scabbards. Includes "S" hook.



Item #	Size	Price / Each	SALE PRICE
449815	48" L	<del>\$9.75</del>	\$8.77



## BUTCHER HANDSAW

- » Stainless steel frame
- » Sturdy ABS handle
- » Easily change blades
- » 20" and 25" blade lengths



Item #	Description	Price / Each	SALE PRICE
420106	20" Butcher Saw	<del>\$42.95</del>	\$38.66
420107	20" Blades, Dozen Pack	<del>\$27.95</del>	\$26.16
420108	25" Butcher Saw	<del>\$44.95</del>	\$40.46
420109	25" Blades, Dozen Pack	<del>\$29.95</del>	\$26.96

# SINKS, BOXES, HEATERS

**MOTION  
ACTIVATED  
ALSO AVAILABLE**



505511



505512

VALVED			
Item #	Dimensions	Price	SALE PRICE
505500	14" W x 17" L x 7" D	<del>\$719.95</del>	<b>\$647.96</b>
505525	16" W x 19" L x 10" D	<del>\$889.95</del>	<b>\$800.96</b>
HANDS FREE			
505527	21" W x 20" L x 19-1/2" D	<del>\$1,329.00</del>	<b>\$1,196.10</b>

## Sani-Lav® WALL MOUNT SINK WITH KNEE VALVES

- » Double knee operated valve provides universal hands free operation
- » Gooseneck faucet with aerator swivels to accommodate cleaning needs
- » Strainer with basket protects drains
- » Wall mounting bracket included

VALVED			
Item #	Dimensions	Price	SALE PRICE
501500	14" W x 17" L x 7" D	<del>\$819.95</del>	<b>\$737.96</b>
501521	16" W x 19" L x 10" D	<del>\$889.95</del>	<b>\$800.96</b>
HANDS FREE			
505526	21" W x 20" L x 41-1/2" D	<del>\$1,429.00</del>	<b>\$1,286.10</b>

## Sani-Lav® PEDESTAL SINK WITH FOOT VALVES

- » Double foot operated valve provides universal hands free operation
- » Gooseneck faucet with aerator swivels to accommodate cleaning needs
- » Strainer with basket protects drains

Item #	Dimensions	Price	SALE PRICE
505511	Heating Element with dial 1100W, 5.5"	<del>\$98.95</del>	<b>\$89.06</b>
505512	Heating Element with dial 1500W, 7"	<del>\$103.95</del>	<b>\$93.56</b>

## STAINLESS STEEL HEATING ELEMENTS

- » Stainless steel case
- » Adjustable dial allows for precise control of temperature
- » On/Off light indicator
- » Fits either a 1" NPT flange or a 1-1/4" opening with a lock nut and gasket included
- » Stainless steel heating rod
- » 6', 3 wire grounded cord and plug



## STANDARD KNIFE STERILIZER BOXES

Item #	Dimensions	Price	SALE PRICE
505555	5" W x 8" H x 8" D	<del>\$122.95</del>	<b>\$110.66</b>



## DELUXE KNIFE STERILIZER BOXES

- » Designed to fit snugly on the rim of our sinks
- » The overflow drains any excess water into sink

Item #	Dimensions	Price	SALE PRICE
505556	6" W x 12" H x 12" D	<del>\$152.95</del>	<b>\$137.66</b>

# TITAN TOUGH BINS, V-EDGE BUGGIES



### 1000 SERIES - 4-WAY ENTRY

Item #	Height	Cubic ft.	Capacity gal/lbs	Color	SALE PRICE
505802	36"	33	245/2000	White	\$409.00
505804	42"	39	290/2400	White	\$431.00
505803	36"	33	245/2000	Gray	\$409.00
505805	42"	39	290/2400	Gray	\$431.00

### 2000 SERIES - 2-WAY ENTRY

Item #	Height	Cubic ft.	Capacity gal/lbs	Color	SALE PRICE
505808	36"	33	250/2000	White	\$409.00
505810	42"	39	295/2400	White	\$434.00
505809	36"	33	250/2000	Gray	\$409.00
505811	42"	39	295/2400	Gray	\$434.00

### 3000 SERIES - 4-WAY ENTRY (REPLACEABLE BOTTOM)

Item #	Height	Cubic ft.	Capacity gal/lbs	Color	SALE PRICE
505816	36"	32	235/1900	White	\$595.00
505817	36"	32	235/1900	Gray	\$595.00

### STACKING & DUST COVER LIDS

Lid	Item #	Color	SALE PRICE
Dust Cover*	505854	Natural	129.00
Stacking	505858	Natural	160.00
Dust Cover*	505855	Gray	129.00
Stacking	505859	Gray	160.00

\*Non-Stacking

**NEW!**

## TITAN TOUGH COMBO BINS

- » Made with FDA approved resin
- » Solid-wall HDPE (High Density Polyethylene) with molded in legs, 2 or 4 way bins, are extremely durable, even at cold temperatures
- » The 3000 & 7000 Series come with bolt-on replaceable 4-way pallet bases. These connect with a unique "seamless" overlapping joint that inhibits bacterial and mold collection and is easy to clean and sanitize - "inspector friendly!"
- » Optional stackable covers to enable up to 3 high stacking for product storage and transport
- » Capacity up to 2,400 lbs.
- » Nestable when empty to save on storage space



501001

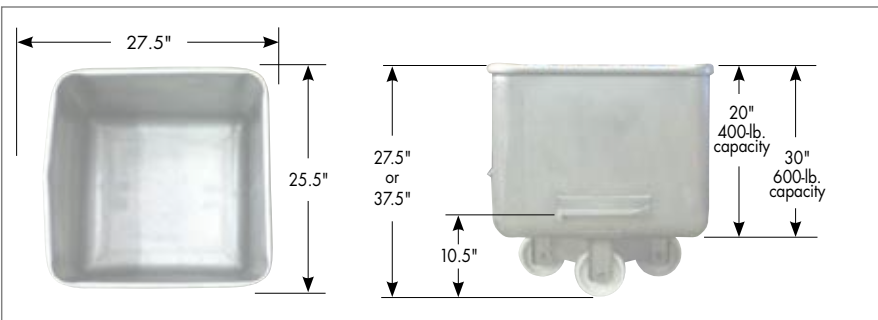

## V-EDGE DUMP BUGGY

American made, solid stainless steel buggy is made for heavy duty use.

- » Solid 1" rolled and welded rim
- » Heavy duty Type 304 stainless steel
- » 2" x 6" white poly wheels with Delrin bushings and greasable zerk axles
- » Stainless wheel support



Item #	Description	Capacity	Shipping Weight	Price Each
501001	No Handle	400-lb.	80-lbs.	\$629.00
501002	No Handle	600-lb.	98-lbs.	\$749.00

### MOLDED LID FOR V-EDGE DUMP BUGGY



Item #	Description	Price Each
501000	Fits Standard V-Edge Dump Buggy	\$29.95

# MEAT LUGS & CARTS

ONLY  
**\$8.99**  
EACH



» Disposable 1.5 mil polyethylene liners that fit poly totes

### POLY TOTE LINER

Item #	Dimensions	Price/Case of 500	SALE PRICE
500110	21" L x 15" W x 22" H	\$69.75	\$62.77

## UltraTote™

Buy fewer totes!

- » Outlasts conventional totes by incorporating more cross ribs for better structural integrity
- » Less flex extends tote life adding money to your bottom line
- » FDA approved for food contact
- » 50-lb. capacity, 1.38 cu. ft.
- » Nested or cross stack design
- » Fits all standard carts
- » Weighs less than 4-lbs.
- » Designed and made in the USA



### FOOD APPROVED UltraTotes

Item #	Description	Price Each	SALE PRICE
500105	White	\$10.49	\$8.99
500106	Gray	\$10.49	\$8.99
500107	Blue	\$10.49	\$8.99
500108	Red	\$10.49	\$8.99
500109	Yellow	\$10.49	\$8.99
500104	Green	\$10.49	\$8.99

### FOOD APPROVED UltraTotes LIDS

500115	Frosted	\$7.75	\$6.97
500116	Gray	\$7.75	\$6.97
500134	Blue	\$7.75	\$6.97

## TOTE CARTS

- » 1.5" diameter, easy grip frame
- » All welded aluminum – will not rust
- » Solid caster hubs with 5" casters
- » Totes sold separately



502006



502007



502003

### INDUSTRIAL STRENGTH POLY TOTE CARTS

Item #	Tote Capacity	Dimensions	Price Each	SALE PRICE
502006	1	24.25" L x 16.5" W x 20" H	\$99.95	\$89.95
502007	2	28.25" L x 16.5" W x 33" H	\$139.95	\$125.95
502003	3	29" L x 16" W x 44" H	\$199.95	\$179.95

## FREEZER BASKETS

Quality Freezer Baskets and Trucks available from UltraSource!

- » Wire basket ends are first welded and then wrapped around top rim
- » Durable construction with 3 gauge rim wire and 10 and 11 gauge body wires
- » Stainless Steel

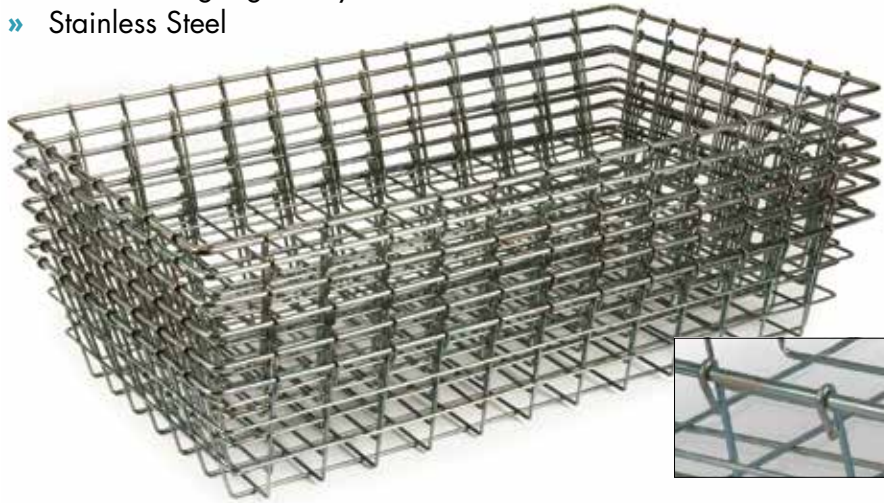

Item #	Dimensions	Price	SALE PRICE
500100	16.5"W x 28"L x 5.25"D	\$24.99	\$22.49

## FREEZER BASKET LINER

Durable 3 mil polyethylene liners manufactured with FDA approved materials including metallocene.



Item #	Dimensions	Price/Case of 100	SALE PRICE
192021	28"W x 30"L x 17"D	\$45.95	\$41.36

## FREEZER BASKET TRUCKS

UltraSource welded aluminum freezer rack frames are constructed of 1.5" x 1.5" square tubing and the sides are 2" x 4" angle.

- » Aluminum frame won't rust
- » Large 5" plate style casters swivel 360 degrees for ease of movement
- » Made in the USA



Item #	Capacity	Dimensions	Price/Each	SALE PRICE
500101	8	20"W x 68.75"H x 29"D, End Load	\$416.95	\$375.25
500102	12	31.5"W x 61.5"H x 35.5"D, Side Load	\$486.95	\$438.25

## COMFORT CURVE BUS BOX

- » Unique reinforced rims reduce bending, bowing, and breaking protecting your valuable tableware investment
- » Incredibly sturdy boxes; smooth interior for easy cleaning
- » Comfort Curve™ handles for a sure, comfortable grip
- » Contour lid design allows easy box-on-box stacking
- » BPA free



5" DEEP BUS BOX				
Item #	Size	Color	Price	SALE PRICE
500111	15" x 20" x 5"	White	\$10.49	\$9.45
500113	15" x 20" x 5"	Gray	\$10.49	\$9.45
7" DEEP BUS BOX				
Item #	Size	Color	Price	SALE PRICE
500117	15" x 20" x 7"	White	\$12.49	\$11.24
500118	15" x 20" x 7"	Gray	\$12.49	\$11.24

# PRODUCT HANDLING

## CHILL TRAY

- » Ventilated design for product temperature control, and minimized cooling time
- » Smooth surfaces for easy cleaning, radius corners prevent product damage
- » FDA approved polyethylene
- » Nest or stack
- » 6" or 13" height



Item #	Dimensions	Price Each	SALE PRICE
500500	24" L x 20" W x 6" H	\$15.95	\$14.36
500501	24" L x 20" W x 13" H	\$26.25	\$23.63

## CHILL TRAY DOLLIES

- » Flow through open base design
- » All aluminum
- » Quiet ride 4" x 2" plate casters



Shown with Optional Handle

Item #	Description	Dimensions	Price Each	SALE PRICE
508904	Single Dolly	19" L x 22.75" W x 10" H	\$169.85	\$152.87
508905	Double Dolly	39" L x 22.75" W x 10" H	\$179.85	\$161.87
508906	Triple Dolly	60" L x 22.75" W x 10" H	\$206.85	\$186.17
508907	Optional Handle	—	\$38.85	\$34.97

## FOOD HANDLING TRAYS 18" W x 26" L



- » Die formed from 16 gauge aluminum
- » Top edge reinforced with wire
- » Stacking design maximizes storage

ALUMINUM		
Item #	Price	SALE PRICE
501219	\$13.95	\$12.55



- » Molded from glass reinforced composite with reinforced edges to ensure strength and stability
- » Resists odors, stains, mildew, chipping, and scratching
- » Smooth, sanitary surface withstands dishwashing and industrial detergents

FIBERGLASS		
Item #	Price	SALE PRICE
501203	\$19.95	\$17.96



- » Seamless construction allows for cleaning ease
- » Corrosion resistance is enhanced by electro polish and passivation

STAINLESS STEEL		
Item #	Price	SALE PRICE
501509	\$64.95	\$58.45

## TRAY RACKS

- » Hold standard 18" x 26" trays
- » 20 tray capacity
- » Available either all welded or knocked down
- » End loading
- » 3" shelf spacing
- » 5" swivel casters included



ASSEMBLED RACK				
Item #	Style	Dimensions	Price Each	SALE PRICE
503013	Laser Cut	21.25"W x 69.75"H x 26"D	\$249.95	\$224.95
503019	Standard	20.25"W x 71.5"H x 25"D	\$249.95	\$224.95

# LARGE TUBS & CARTS

## TUBS & CARTS

Tubs and tub accessories offer a combination of durability and versatility. Manufactured from high-density polyethylene, they can be used for transporting, freezing and storing.



### 800-LBS. CAPACITY ANGLED DUMP TUB WITH OR WITHOUT DRAIN

White Item #	Blue Item #	Green Item #	Red Item #	Yellow Item #	Description	Dimensions	Prices	SALE PRICE
509600	509601	509602	509603	509604	No Drain	54.6"L x 32"W x 21.7"H	\$318.95	\$287.05
509605	509606	509607	509608	509609	Drain	54.6"L x 32"W x 21.7"H	\$384.95	\$346.45

### LID FOR ANGLED DUMP TUB

White Item #	Blue Item #	Green Item #	Red Item #	Yellow Item #	Dimensions	Prices	SALE PRICE
509610	509611	509612	509613	509614	56"L x 32"W x 4.3"H	\$168.95	\$152.05

### UNDERCARRIAGE FOR ANGLED TUB

Item #	Product Code	Description	Weight	Dimensions	Prices	SALE PRICE
509630	6903	Galvanized Steel	69.5-Lbs.	41.1"L x 27.3"W x 19.1"H	\$598.95	\$539.05
509631	6904	Galvanized Steel - Low Undercarriage	85.5-Lbs.	40.25"L x 26.9"W x 8.9"H	\$578.95	\$521.05
509632	6906	Stainless Steel	57-Lbs.	41.1"L x 27.3"W x 19.1"H	\$876.95	\$789.25



### 500-LBS. CAPACITY RECTANGLE STORAGE TUB WITH OR WITHOUT DRAIN

White Item #	Blue Item #	Green Item #	Red Item #	Yellow Item #	Description	Dimensions	Prices	SALE PRICE
509615	509616	509617	509618	509619	No Drain	46.8"L x 26.5"W x 16.9"H	\$394.95	\$355.45
509620	509621	509622	509623	509624	Drain	46.8"L x 26.5"W x 16.9"H	\$323.95	\$291.55

### LID FOR RECTANGLE STORAGE TUB

White Item #	Blue Item #	Green Item #	Red Item #	Yellow Item #	Dimensions	Prices	SALE PRICE
509625	509626	509627	509628	509629	46.9"L x 26.9"W x 1.7"H	\$168.95	\$152.05

### UNDERCARRIAGE FOR RECTANGLE TUB

Item #	Product Code	Description	Weight	Dimensions	Prices	SALE PRICE
509633	6913	Galvanized Steel - Low Undercarriage	57.5-Lbs.	42.5"L x 21.6"W x 9.4"H	\$461.95	\$415.75

# RETRACTABLE PREP STATION, TABLES

## RETRACTABLE PREP STATION

Need more room? We have the answer! UltraSource's wall mounted prep station maximizes your productivity, and then folds up when not needed.

- » Space saving design that mounts on the wall and folds up
- » 16 gauge stainless steel construction
- » Includes an under and a cantilever shelf
- » Work surface is 24" deep with a three sided 1-3/4" backsplash
- » Handles up to a 500-lb. distributed load on the work surface
- » Ships fully assembled with mounting hardware



Item #	Description	Price Each	SALE PRICE
506036	Retractable Prep Station 36"	\$729.00	\$656.10
506048	Retractable Prep Station 48"	\$799.00	\$719.10
506136	Bolt on Wheel Assembly for 36" Prep Station	\$239.00	\$215.10
506148	Bolt on Wheel Assembly for 48" Prep Station	\$249.00	\$224.10

## POLY TOP TABLES

- » Heavy duty 3/4" poly top
- » All aluminum frame
- » Adjustable bullet feet
- » Removable top for easy cleaning
- » Optional backsplash available



Item #	Description	Size W x H x L	Weight	Price	SALE PRICE
503036	1-Piece Poly Top	30" x 34" x 36"	42-lbs.	\$265.00	\$238.50
503048	2-Piece Poly Top	30" x 34" x 48"	56-lbs.	\$308.00	\$277.20
503060	3-Piece Poly Top	30" x 34" x 60"	70-lbs.	\$357.00	\$321.30
503072	3-Piece Poly Top	30" x 34" x 72"	79-lbs.	\$411.00	\$369.90

## STAINLESS STEEL TOP TABLES

- » All aluminum frame
- » Adjustable bullet feet
- » Ships knocked down
- » Easy to assemble
- » Optional backsplash available



Item #	Description	Size W x H x L	Weight	Price	SALE PRICE
523036	Stainless Top	30" x 34" x 36"	31-lbs.	\$355.00	\$319.50
523048	Stainless Top	30" x 34" x 48"	46-lbs.	\$416.00	\$374.40
523060	Stainless Top	30" x 34" x 60"	52-lbs.	\$485.00	\$436.50
523072	Stainless Top	30" x 34" x 72"	63-lbs.	\$560.00	\$504.00



## STAINLESS STEEL SHOVELS

- » Electro polished to resist corrosion and improve ease of cleaning
- » NSF Certified



Item #	Dimensions	Price Each	SALE PRICE
500210	10-3/4" W x 15" Round Blade x 40" H	<del>\$151.95</del>	\$136.76
500211	9-1/2" W x 12-1/2" Square Blade x 40" H	<del>\$151.95</del>	\$136.76

## PLASTIC SHOVELS

- » One piece molded shovel is durable and hygienic
- » Constructed from FDA compliant polypropylene
- » Color coded for integration in a HACCP program



Item #	Description	Color	Price Each	SALE PRICE
500243	11" W x 14" Blade x 38" H	Red	<del>\$38.50</del>	\$34.65
500240	11" W x 14" Blade x 38" H	White	<del>\$38.50</del>	\$34.65
500244	11" W x 14" Blade x 38" H	Yellow	<del>\$38.50</del>	\$34.65
500248	14" W x 17" Blade x 42" H	Red	<del>\$39.50</del>	\$35.55
500245	14" W x 17" Blade x 42" H	White	<del>\$39.50</del>	\$35.55
500249	14" W x 17" Blade x 42" H	Yellow	<del>\$39.50</del>	\$35.55
500345	14" W x 17" Blade x 42" H	Black	<del>\$39.50</del>	\$35.55
500247	14" W x 17" Blade x 42" H	Blue	<del>\$39.50</del>	\$35.55
500246	14" W x 17" Blade x 42" H	Green	<del>\$39.50</del>	\$35.55

## PLASTIC PADDLES

- » Mix and scrape with these lightweight plastic paddles
- » Hygienic one piece molded construction
- » Color coded for integration in a HACCP program



WITH HOLES				
Item #	Color	Handle Length	Price Each	SALE PRICE
500263	Red	40"	<del>\$46.95</del>	\$42.26
500260	White	40"	<del>\$46.95</del>	\$42.26
500264	Yellow	40"	<del>\$46.95</del>	\$42.26
500273	Red	52"	<del>\$46.95</del>	\$42.26
500270	White	52"	<del>\$46.95</del>	\$42.26
500274	Yellow	52"	<del>\$46.95</del>	\$42.26
WITHOUT HOLES				
Item #	Color	Handle Length	Price Each	SALE PRICE
500268	Red	40"	<del>\$54.95</del>	\$49.46
500265	White	40"	<del>\$54.95</del>	\$49.46
500269	Yellow	40"	<del>\$54.95</del>	\$49.46
500278	Red	52"	<del>\$54.95</del>	\$49.46
500275	White	52"	<del>\$54.95</del>	\$49.46
500279	Yellow	52"	<del>\$54.95</del>	\$49.46

## SCRAPERS/DOUGH CUTTERS

Perfect multi-tool to use for moving bulk material, dividing large batches, or scraping clean work tables, buggies, totes, etc.

### STAINLESS STEEL SCRAPERS/DOUGH CUTTERS

- » Seamless one piece stainless steel
- » Comfortable rolled edge handle



### PLASTIC SCRAPERS/ DOUGH CUTTERS

- » Hygienic one piece molded plastic construction
- » Molded hand grip



Item #	Dimensions	Type	Price Each	SALE PRICE
449500	6" W x 3" H	Stainless Steel	<del>\$10.95</del>	\$9.86
500290	8.5" W x 5.5" H	Plastic/White	<del>\$9.95</del>	\$8.96
500291	8.5" W x 5.5" H	Plastic/Green	<del>\$9.95</del>	\$8.96

# WASTE MANAGEMENT & BULK MOVERS

## INDUSTRIAL STRENGTH CONTAINERS & LIDS

- » Heavy duty, made in USA construction with double reinforced stress ribs
- » Ergonomic Comfort Curve™ handles provide easy handling, even when full
- » Deep hand holds on base for safe controlled tipping or overhead lifting
- » BPA free NSF Std. 21 and NSF Std. 2 containers and lids for food contact and cleanability



20 GALLON LIDS				
Item #	Size	Color	Price	SALE PRICE
509330	20 Gal	White	\$6.95	\$6.25
509331	20 Gal	Yellow	\$6.95	\$6.25
509332	20 Gal	Red	\$6.95	\$6.25
509335	20 Gal	Gray	\$6.95	\$6.25
32 GALLON LIDS				
509350	32 Gal	White	\$8.49	\$7.64
509351	32 Gal	Yellow	\$8.49	\$7.64
509352	32 Gal	Red	\$8.49	\$7.64
509355	32 Gal	Gray	\$8.49	\$7.64
44 GALLON LIDS				
509370	44 Gal	White	\$15.49	\$13.94
509371	44 Gal	Yellow	\$15.49	\$13.94
509372	44 Gal	Red	\$15.49	\$13.94
509375	44 Gal	Gray	\$15.49	\$13.94
55 GALLON LIDS				
509395	55 Gal	Gray	\$22.49	\$20.24
509391	55 Gal	Yellow	\$22.49	\$20.24

» White and Red lids not shown

## BULK MOVERS & TUBS

- » Multi purpose, labor saving carts
- » Seamless FDA approved polyethylene tubs
- » 1-1/2" diameter, easy grip tubing

**INCLUDES CART & TUB!**



Item #	Bushels	Gallon Capacity	Price Each	SALE PRICE
529383	4	30	\$309.95	\$278.96
529363	6	41	\$329.95	\$296.96
529394	8	57	\$349.95	\$314.96
529393	9	66	\$399.95	\$359.96

20 GALLON CONTAINERS				
Item #	Description	Color	Price	SALE PRICE
509320	Waste Container	White	\$20.95	\$18.85
509321	Waste Container	Yellow	\$20.95	\$18.85
509322	Waste Container	Red	\$20.95	\$18.85
509325	Waste Container	Gray	\$20.95	\$18.85

32 GALLON CONTAINERS				
509340	Waste Container	White	\$26.95	\$24.25
509341	Waste Container	Yellow	\$26.95	\$24.25
509342	Waste Container	Red	\$26.95	\$24.25
509345	Waste Container	Gray	\$26.95	\$24.25
509347	Stamped "Inedible"	Gray	\$34.95	\$33.95
509346	Stamped "Inedible"	Red	\$28.95	\$26.05
509348	Stamped "USDA Condemned"	Yellow	\$36.95	\$33.26
509349	Stamped "Trash"	Gray	\$34.95	\$33.95

44 GALLON CONTAINERS				
509360	Waste Container	White	\$39.75	\$35.77
509361	Waste Container	Yellow	\$39.75	\$35.77
509362	Waste Container	Red	\$39.75	\$35.77
509364	Waste Container	Gray	\$39.75	\$35.77

55 GALLON CONTAINERS				
509385	Waste Container	Gray	\$61.95	\$55.75
509381	Waste Container	Yellow	\$61.95	\$55.75
509382	Waste Container	Red	\$61.95	\$55.75

- » Ships UPS Oversized 44 and 55 Gallon
- \* Oversized items do not qualify for free shipping

## SCOOPS

Great for moving bulk materials, these scoops are constructed of one piece molded plastic construction or stainless steel that prevents bacterial growth.

- » Certified NSF Standard 2 food equipment

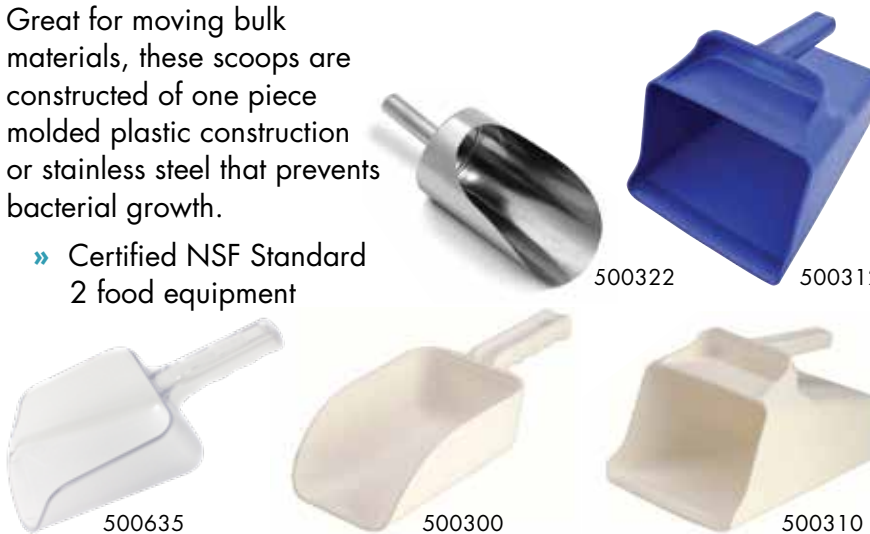

Item #	Capacity	Type	Price/Each	SALE PRICE
500634	6-oz.	Plastic/Clear	\$2.49	\$2.24
500635	32-oz.	Plastic/Clear	\$5.95	\$5.36
500300	32-oz.	Plastic/White	\$4.95	\$4.46
500301	32-oz.	Plastic/Green	\$4.95	\$4.46
500304	32-oz.	Plastic/Yellow	\$4.95	\$4.46
500305	82-oz.	Plastic/White	\$5.49	\$4.94
500310	128-oz.	Plastic/White	\$10.95	\$9.86
500312	128-oz.	Plastic/Blue	\$10.95	\$9.86
500321	16-oz.	Stainless Steel	\$54.95	\$49.46
500322	32-oz.	Stainless Steel	\$59.95	\$53.96
500323	64-oz.	Stainless Steel	\$72.95	\$65.66

# ROLLSTOCK FILM

VOUCHER  
**\$500**

## \$500 ROLLSTOCK FILM TEST VOUCHER!

Complete an onsite UltraSource Rollstock Film Test and get a \$500 Voucher for any supplies, parts or equipment

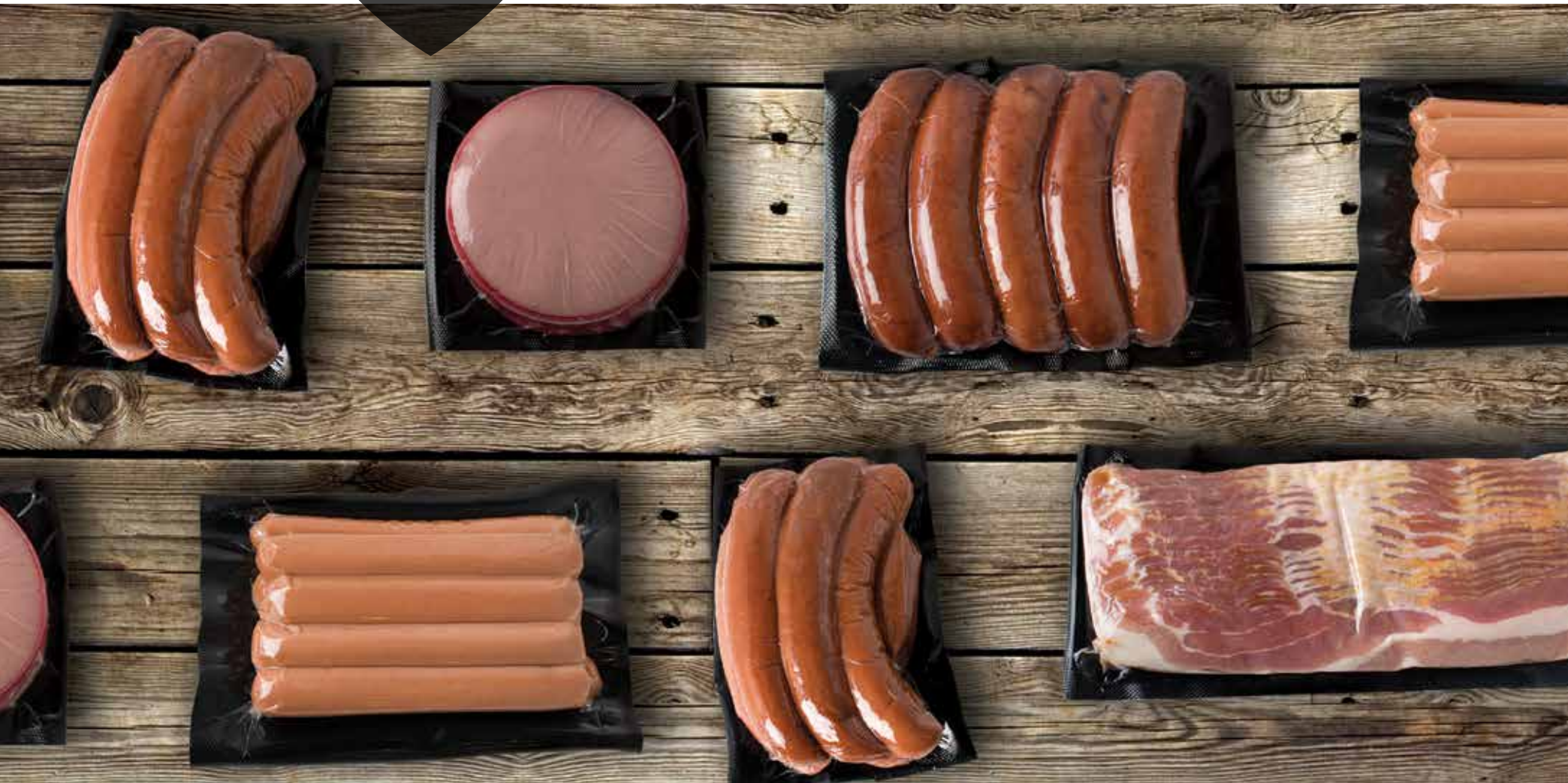

- » Value priced with unsurpassed clarity & quality
- » **FREE** shipping customized to your needs
- » No minimum order requirements

### NO MINIMUM ORDER REQUIREMENTS!

In addition to all of these benefits, you can order just what you need, not what your supplier demands you order. This allows you to reduce inventory, helping with cash flow and storage.

CALL US NOW!  
**FOR A FREE ROLL**

**2.5 MIL – 12 MIL AVAILABLE**



**BLACK FILM**



**RANDOM PRINT FILM**



**HIGH BARRIER FILM**



**HIGH TEMP FILM**

# Ultravac® VACUUM CHAMBER MACHINES

ULTRAVAC® THE BRAND PROFESSIONAL CHEFS & PROCESSORS TRUST!

WATCH VIDEOS »



PACKAGING + PROCESSING EQUIPMENT



## Ultravac® 225

- » 16" seal bar
- » 7.2" chamber depth
- » 1.25-hp vacuum pump
- » Analog control panel
- » Electrical: 110 volt, single phase
- » Made by UltraSource in the USA
- » NSF-2 with kit

2 YEAR WARRANTY



## Ultravac® 250

- » 16" seal bar
- » 6.75" chamber depth
- » 1.25-hp vacuum pump
- » Digital control panel
- » Electrical: 110 volt, single phase
- » Made by UltraSource in the USA
- » NSF-2

2 YEAR WARRANTY



## Ultravac® 500

- » Two 18" seal bars
- » 9" chamber depth
- » 2-hp vacuum pump
- » Hot wire cutoff
- » Digital control panel
- » Locking casters
- » Electrical: 230 volt, 1-phase
- » Made by UltraSource in the USA
- » NSF-2

2 YEAR WARRANTY



3 SEAL BARS

2 YEAR WARRANTY



## Ultravac® 700

- » Three seal bars: two 20" side and one 24" front
- » 9" chamber depth
- » 3-hp vacuum pump
- » Hot wire cutoff
- » Digital control panel
- » Electrical: 230 volt, 3-phase
- » Made by UltraSource in the USA
- » Shown with optional touchscreen

TABLETOP DEAL!

Ultravac® 225 & Ultravac® 250

» 25 YEARS OF QUALITY MACHINES

TRUSTED CHOICE OF THE BEST CHEFS & PROCESSORS IN AMERICA

**\$250 OFF!\***

\*WITH PURCHASE OF AN Ultravac® 255 OR Ultravac® 250

## SINGLE CHAMBER DEAL

Ultravac® 400 Ultravac® 600  
Ultravac® 500 Ultravac® 700

QUALIFY FOR:

POSSIBLE UPGRADE OPTIONS

**\$500 OFF!**

OR FREE UPGRADE

- » CASTER WHEELS
- » GAS FLUSH
- » DOUBLE SEAM SEAL BAR
- » TOUCHSCREEN
- » + MORE!

# Ultravac® 2100

- » 8" or 12" chamber depth
- » 26.5" seal bars
- » Electrical: 1-phase\* or 3-phase
- » 4 pump sizes available: 5\*, 7.5, 10, 12-hp Busch®, vacuum pumps
- » Made by UltraSource in the USA

\*Available in 5hp pump, 8" lid, single phase electric configuration only

**2** YEAR WARRANTY



PACKAGING + PROCESSING EQUIPMENT

**#1 BEST SELLING & AMERICAN MADE**

**NOW WITH SINGLE PHASE OPTION!**

**PICK 2!**

GET AN ULTRAVAC 2100 WITH YOUR PICK OF ANY 2 OPTIONS FOR ONLY **\$16,495**

## UP TO A \$2,900 VALUE! ULTIMATE ULTRAVAC 2100 VACUUM PACKAGING BUNDLE

- |   |   |
|---|---|
| <input type="checkbox"/> Upgrade from 8" to 12" Depth Lid | <input type="checkbox"/> 10mm Wide Band Seal    |
| <input type="checkbox"/> Pre Cut Knife System             | <input type="checkbox"/> GAS Flush              |
| <input type="checkbox"/> Spare Parts Kit                  | <input type="checkbox"/> Vacuum Pump HP Upgrade |
| <input type="checkbox"/> Caster Wheels                    | <input type="checkbox"/> Clear View Filter      |
| <input type="checkbox"/> Inline Filter                    |   |

\*Bundle price does not include shipping or taxes.



**CALL US NOW TO PICK 2 FOR \$16,495!**  
**800.777.5624**

# Ultravac® VACUUM CHAMBER MACHINES

PACKAGING + PROCESSING EQUIPMENT



**BELTED**  
Automated conveyor belt

» EASILY PAIRS WITH ULTRASHRINK 3012 AUTOMATIC SHRINK TUNNEL

**UltraShrink 3012 AUTOMATIC SHRINK TUNNEL**  
30" opening compatible with any chamber machine or conveyor.



## Ultravac® 3500

**2** YEAR WARRANTY



- » Patented conveyor system with easily removable conveyor belt
- » 39" seal bars
- » 10mm wide band seals
- » Dual 10-hp or 12-hp pumps
- » 12" lid height

WATCH VIDEO »



## WANT TO ENHANCE THE APPEARANCE OF YOUR PACKAGING? CONSIDER SHRINK PACKAGING WITH THE UltraShrink™ 2818 DIP TANK!

Are you thinking about making the jump from vacuum pouches to shrink bags? Then consider our stainless steel UltraShrink™ 2818 Dip Tank for contoured retail packaging!

- » Large 28" x 18" platform
- » Minimal splash
- » Elevated controls
- » Variable speed control
- » Any voltage available

WATCH VIDEO



### LOOKING FOR MORE AUTOMATION?

Look at the UltraShrink™ Shrink Tunnel that easily pairs with the Ultravac 3500!

## UltraShrink™ 2818 DIP TANK FOR ENTRY LEVEL SHRINK BAG APPLICATIONS



# Rhino® TRAY SEALERS

NSF



PROUDLY MADE BY  
UltraSource®  
IN THE USA

1 YEAR  
WARRANTY

WATCH  
VIDEO



Rhino®  
**4**



NSF



PROUDLY MADE BY  
UltraSource®  
IN THE USA

1 YEAR  
WARRANTY

WATCH  
VIDEO



Rhino®  
**10**



NSF



PROUDLY MADE BY  
UltraSource®  
IN THE USA

1 YEAR  
WARRANTY

WATCH  
VIDEO



Rhino®  
**12**



PACKAGING + PROCESSING EQUIPMENT



RHINO® DEAL  
QUALIFY FOR:

0% 48 MONTH  
FINANCING  
OR  
FREE GAS  
ANALYZER



**ACT NOW TO COST EFFECTIVELY BOOST YIELDS,  
PRODUCT APPEARANCE & FRESHNESS  
WITH A RHINO TRAY SEALING MACHINE!**

Disclaimer: This offer cannot be combined with other offers. Dealers and distributors are not eligible for promotional offers. Financing options are for United States customers and are dependent upon third party credit approval and terms. Customers that buy Rhino tray sealer are eligible for one free gas analyzer or to qualify for 0% 48 month financing.

## FERMENTATION & DRYING ROOMS



### MAUTING KMZ FERMENTATION ROOM

Designed mostly for the first phase of fermentation of thermally non-processed meat products.

- » The first phase of fermentation, start of fermentation
- » Smoking by cold smoke
- » Maturing
- » Intensive drying

Operative temperature range is 18 ÷ 30 °C at regulated humidity in the range of 65 ÷ 95%. Standard dehumidifying output of the equipment is up to 3%/24 hours at the chamber temperature of 18°C and relative humidity of 75%.

Smoke generation can be carried out either in the wooden chip or friction smoke generator according to the client's requirement.



### MAUTING KMD DRYING ROOM

Designed for the second phase of fermentation of thermally non-processed products or drying of thermally processed products. They can be equipped with smoke generators for creation of smoke aroma.

- » For second phase of fermentation
- » Drying

Standard operative temperature range is 15 ÷ 22 °C at regulated humidity in the range of 65 ÷ 90%. Dehumidifying output of the equipment is 1-1,5% / 24 hours on the average according to the type of the product, casing and production technology related to the temperature of 15 °C and relative humidity of 70%. The Cross Flow system allows the dehumidification up to 2,5%/24 hours.

# SMOKEHOUSES



**QUALIFY FOR:**

**UP TO 72 MONTHS  
FINANCING  
OPTIONS  
AVAILABLE\***

\* US based customers who qualify via 3rd party financing firms. Restrictions apply.

**ASK HOW TO ATTEND  
A FREE UltraSource ACADEMY!**



## UKM CLASSIC SMART DESIGN

### SMART Design Advantages

- » Flush door
- » Pneumatic door opening
- » Operational signal lights
- » Touch screen control panel
- » Up to 12 truck configurations



## GRAND PRIZE™ 3 SMOKEHOUSE

### FEATURES:

- » Humidity control system
- » Forced air
- » Product shower
- » Cleaning nozzles

PACKAGING + PROCESSING EQUIPMENT



## UKM CLASSIC

High efficiency houses with incredible air flow and smoke generation.

### FEATURES:

- » Wood chip or friction block smoke generator
- » Microprocessor control system allows for custom programming and data recording
- » Electric, gas, or steam heated
- » Multiple smoke truck configurations
- » Automatic cleaning system

### OPTIONS AVAILABLE:

- » Walk through tunnel versions
- » Changing flaps
- » SMART Design
- » Touch screen microprocessor
- » Liquid smoke
- » Cold smoking

**THE BEST  
VALUE  
SMOKEHOUSE  
AVAILABLE!**



### EASY ACCESS

Access your smokehouse through your phone, tablet or PC!



## FULLY AUTOMATIC DOUBLE CLIPPER CDC-A SERIES

The fully automated CDC-A Series Double Clipper combines performance, reliability and flexibility. The CDC-A Series Double Clippers are solidly built and efficient. Because of the two-hand release, the CDC-A Series offers the highest safety standards. CDC-A Series clippers are mechanically and electrically compatible with all commercially available stuffing machines. The mobile base enables easy adjustment of the clipper to the height of the stuffer.

### FEATURES:

- » The service intervals on board are controlled by a special CRM program
- » Intuitive user friendly controls
- » High quality stainless construction for durability and easy cleaning
- » Electronically controlled, operated pneumatically, easy maintenance, low cost
- » Quick change of up to 4 different clip types without requiring any modification
- » Large caliber range



WATCH VIDEO



## SEMI AUTOMATIC DOUBLE CLIPPER SERIES (B90, 800, 200)

The CDC series double clipper is a solidly built machine that promotes safe operation, high productivity and flexibility. The adjustable base of the machine makes it easy to connect with most standard stuffing machines. It enables manufacturers to provide new products quickly and easily and process existing products routinely and efficiently. The CDC will help you to save time and money.

### FEATURES:

- » High flexibility, large caliber range and simple operation
- » Built to last with stainless steel and service and hygiene friendly design
- » Pneumatically controlled and operated for easy maintenance and low cost
- » No matter how the CDC is configured - it does not require any electricity
- » Quick change of up to 4 different clip types without requiring any modification
- » Can be connected to all commercially available stuffing machines



WATCH VIDEO



## TABLETOP SINGLE & DOUBLE CLIPPERS

### SINGLE: CLIPSTAR SERIES

(200, 700, 800, 800 PACK, B90)

### DOUBLE: CDC (200, 800)

### EASY PLUS

CDC (200, 800, B90)

Select from a wide range of single and double tabletop Cliptechnik clippers to accommodate your product clipping needs. Safely and securely close all kinds of natural and artificial casings as well as all types of bags used in a modern sausage production. All clip machines - CDC- and Clip Star series - are prepared with up to four different clip dimensions and can be processed without exchanging machine parts.



## HIGH PERFORMANCE CLIPPERS MADE IN GERMANY

# MIXERS/GRINDERS, STUFFERS, BOWL CUTTERS, INJECTORS

## THOMPSON SERIES MIXERS/GRINDERS

A wide range of seamless, fully welded, heavy duty stainless steel mixers and grinders from 60 liter to 1,600 liter hopper capacity.

Increase your production yields and product quality consistency with Thompson Mixer/Grinders. Easy to clean and built to withstand harsh operating environments for long life.

### 3000 SERIES OPTIONS:

- » Footswitch
- » Connections for tandem (Gemini) production
- » Bone removal system
- » Safety interlocked discharge guard
- » Ingredients chute

### 4000 SERIES OPTIONS:

- » 8-5/8" (#66) grinding head
- » Variable speed drives
- » PLC programmable controls
- » Digital thermometer
- » Connections for tandem (Gemini) production
- » Pneumatic lid
- » CO<sup>2</sup> cooling
- » Bone removal system
- » Feedscrew, knife, and plate cart
- » Ingredients chute



## INJECT STAR® INJECTORS

- » Bone-in or boneless meat
- » Quick release needles
- » Synthetic conveyor belt
- » Suitable for beef, poultry
- » Hand pump outlet



## A FULL RANGE OF VACUUM STUFFERS FOR ALL TYPES OF PRODUCTION:

A wide range of seamless, fully welded, heavy duty stainless steel

- » Increased speed
- » Instantaneous stop and start precision
- » Exact weight portions
- » High quality, consistent products
- » Full color touch screen control panels



## AUTOMATIC HANGING LINE WITH LINKING SYSTEM

Optimize your sausage or snack stick production line.

## FATOSA BOWL CUTTERS

UltraSource offers a full line of USDA accepted stainless steel floor model bowl cutters with capacities ranging from 35 liters up to 325 liters for small to medium/ large size processing facilities. Manufactured from heavy duty stainless steel with a hygienic clean design and a smooth surface making cleaning effortless. Solid body construction and rubber feet minimize and absorb vibrations.

### C-75VV SPECIFICATIONS:

- » **CAPACITY** 75 liters
- » **KNIFE SPEED** 150 to 5,000 r.p.m.
- » **BOWL SPEED** 5/12/18 r.p.m.
- » **MIXING SPEED** 150 r.p.m.

### C-75VV STANDARD FEATURES:

- » Six knives
- » Emergency stop
- » Knife brake
- » Unloader
- » Electronic controls
- » Variable speed
- » Digital thermometer
- » Five preset cutting speeds
- » Three preset bowl speeds
- » Auto shut-off by time, temperature, or bowl revolutions



# KILL FLOOR, SAUSAGE PEELERS & PROCESSING EQUIPMENT

**NEW!**

## MSP 3008 SEMI-AUTO SAUSAGE PEELER

- » Fast and functional, adaptable to any work area
- » Easily disassembles for wash-down
- » Automated sausage traction
- » Adaptable for different diameters 15-34mm
- » No cutting marks



**NEW!**

## ASP 200 AUTO SAUSAGE PEELER

- » Vacuum pump included
- » Special blade for cutting without marking sausage
- » Product entry equipped with anti-burn air curtain
- » Easy height adjustment for sausage diameter between 15 and 34mm
- » Supervising window on and auto light for enclosure for peeled casing
- » Product water bin easily removable for washing



## CSDM BM 20S | SCALDS & DEHAIRS PIGS & GOATS FROM 25-500 LBS.

### FEATURES

- » Over sized bristle collection box
- » Two water outlets
- » Left/right on/off switches
- » Safety switch
- » Bristle flap (front side of machine)

### OPTIONAL FEATURES

- » Pneumatic ejector
- » Electronic control box



PERFECT COMBINATION TO INCREASE YIELD

## MAJA EQUIPMENT

UltraSource offers MAJA derinders, membrane skimmers, and flake ice machines. For almost 60 years, MAJA has been at the forefront of high quality, innovative processing equipment for the protein market. UltraSource and MAJA: an unbeatable combination for your success.



## BELLIES & HAMS ON ONE MACHINE



SPECIFICATIONS	CSDM BM 20S
Hog Capacity/Hour	Up to 15
Outside Dimensions	100"L x 37.2"W x 52.5"H
Length of Tank	78.75"
Electrical	230 Volt, 3-phase
Heating Element	15 kW
Weight	1,433-lbs. (650kg)

### ESB 4434/1 AND SKINNY II DERINDER

Type	Cutting Width	Width of Machine	Depth of Slide Sheet	Depth with Discharge Conveyer	Height of Machine	Power Requirement	Weight
ESB 4434	17.9" (434mm)	33.43" (849mm)	52.8" (1340mm)	---	48.9" (1242mm)	1-hp 208-230/460v 60Hz	518-lbs. (235kg)
ESB 4434/1	17.9" (434mm)	33.43" (849mm)	---	69.2" (1757mm)	48.9" (1242mm)	1-hp 208-230/460v 60Hz	551-lbs. (250kg)
Skinny II	17.9" (434mm)	31.86" (809mm)	52.8" (1368mm)	47.4" (1205mm)	47.4" (1205mm)	1-hp 208-230/460v 60Hz	419-lbs. (190kg)

# A FULL LINE OF LABELING SOLUTIONS

PACKAGING + PROCESSING EQUIPMENT



## MATRIX™ CROSSWEB PACKAGE TOP LABELER

Label placement is critical when it is the only thing on your package. UltraSource's PT Package Top Labeler reduces your labor cost and provides a rapid return on investment over conventional hand labeling. Angled surfaces and rounded corners facilitate better water runoff for wash down conditions, and exceed NEMA 4 ratings. Patented height adjustable tamp unit speeds tamp time and improves placement accuracy to ±0.5mm.

- » Conforms to most product contours
- » Optional servo motors for very high speed applications
- » Designed for ease of maintenance and inspection
- » Perfect for placement of promotional labels on pre-printed film

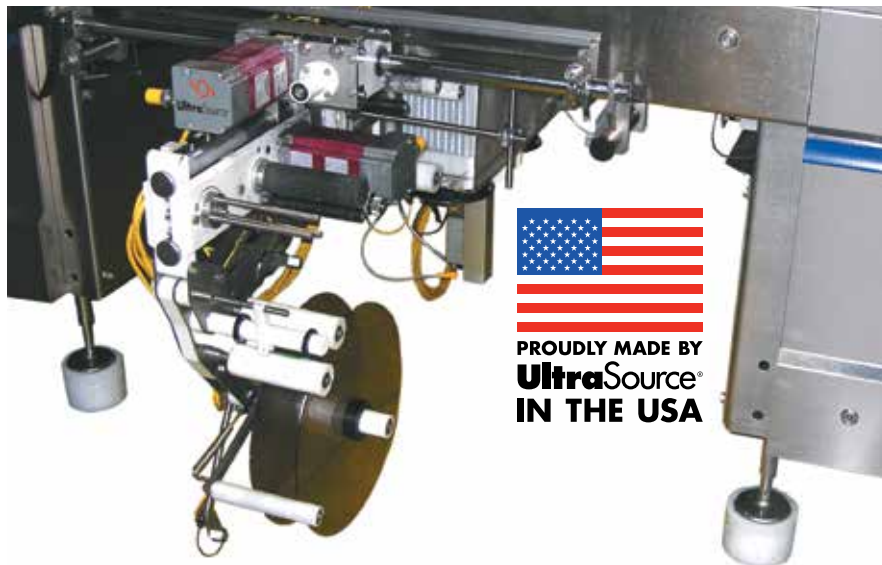

PROUDLY MADE BY  
**UltraSource**  
IN THE USA

## MATRIX™ CROSSWEB PACKAGE BOTTOM LABELER

All the great features of our Matrix labeling system in a bottom mount, knee free design.

- » Ideal for placement of ingredients, UPC, and nutritional information
- » Conforms to most product contours
- » Designed for wash down environments



## POSI 200 TOP & BOTTOM AUTOMATIC PACKAGING LABELING SYSTEM

Our Posi 200 affixes pressure sensitive labels to the top and/or bottom of flexible or rigid packages, trays, or boxes, and is well suited for in line labeling applications fed directly from food packaging machines.

- » Constructed primarily of stainless steel and Delrin plastic
- » Small footprint saves space and wheels provide portability
- » Built to NEMA 4 specifications for wash down
- » Quick release conveyor belts for ease of cleaning
- » Bottom labeler head slide out feature for easy label threading



## MATRIX™ CROSSWEB FILM LABELER

High speed accuracy for difficult film labeling applications. UltraSource's Matrix crossweb automatic film labeler couples state-of-the-art technology to a conventional mounting solution. Top mounted design features a wide range of adjustments to suit multiple applications.

- » High speed accuracy for applying labels within constraints of pre-printed film
- » Compact design for space efficiency
- » Conforms labels to contours or multiple surface heights
- » Touch screen controls

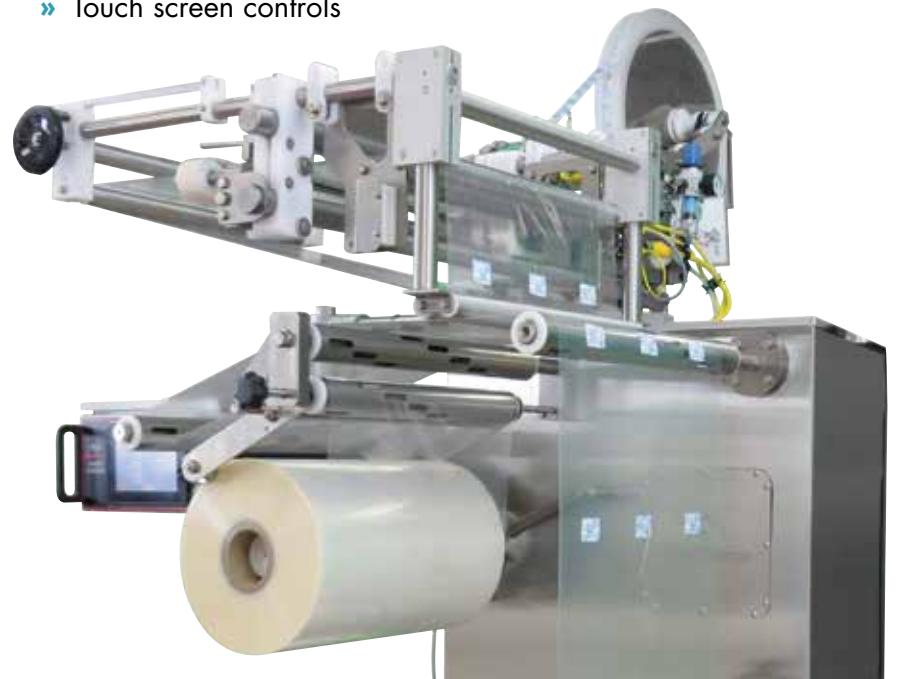

# THE MATRIX™ ULTRA LABELER

## MATRIX ULTRA LABELER ADVANTAGES

- » 40 to 60% savings over conventional mounted labeling systems
- » Portability for use on multiple machines and applications
- » Small footprint provides functionality in limited and low clearance environments
- » Patented

### ADDITIONAL FEATURES

- » Ideal for labeling direct to the film on a rollstock machine
- » User friendly touch screen controls
- » Designed and built by UltraSource in the USA
- » NEMA 4 wash down rated for dependability and hygiene



PACKAGING + PROCESSING EQUIPMENT



2019 PACK EXPO  
TECHNOLOGY EXCELLENCE  
AWARD FINALIST

REDUCE COST  
BY UP TO  
**60%**  
VS. CONVENTIONAL  
FILM LABELING SYSTEMS

STARTING AT  
**\$17K**

# WEIGH PRICE LABELING EQUIPMENT

## ESPERA® ES 5900

### SEMI AUTOMATIC WEIGH PRICE LABELING

The compact solution in price labeling. The semi automatic price labeling system requires small floor space and is available as a standalone solution for manual product feed as well as for integrating into existing production lines via automatic product feed. The 5911 supports **up to 65 packages per minute** and is easy to operate via a color touch-display.

#### FEATURES

- » Up to 2 printers Top/1 Bottom
- » Compact and space-saving design
- » No external compressed air

WATCH VIDEO »



## ESPERA® ES 6000

### SEMI AUTOMATIC WEIGH LABELER FOR CASES & HEAVY PRODUCTS

This outstanding labeling solution weighs and labels products up to 176 lbs (80 kg). This machine can be easily integrated into existing lines or act as a standalone unit. It can be equipped with up to two printers that can label the top and/or any side of the product (except the bottom).

#### FEATURES

- » Hygienic stainless steel design and removable conveyor belts for easy cleaning
- » No external compressed air required
- » Fast change of label reels by servo device
- » Easy replacement of thermal print heads without the need for service
- » Online remote service included at no additional charge
- » Full network integration possible

WATCH VIDEO »



# BULLDOG® & BISON® ROLLSTOCK MACHINES

PACKAGING + PROCESSING EQUIPMENT

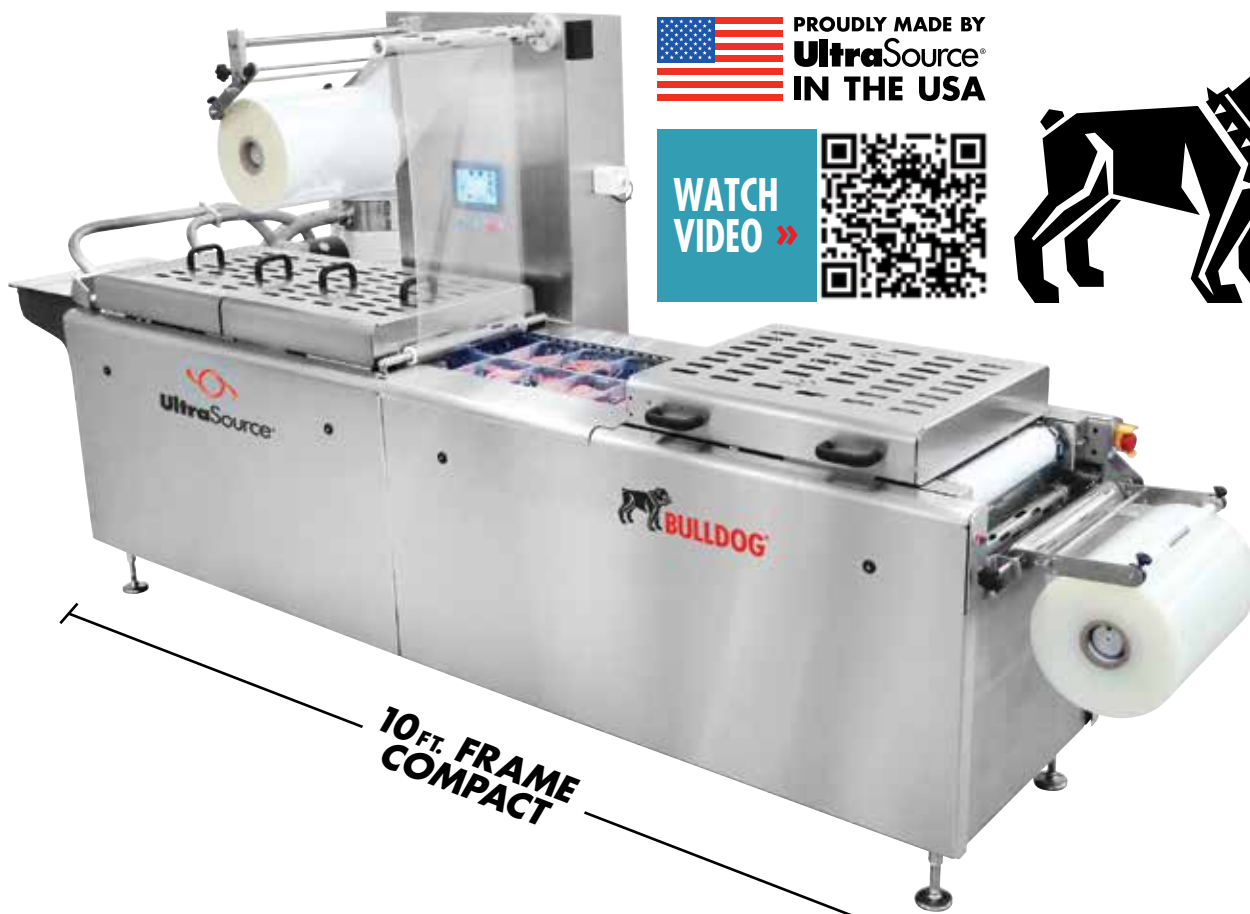

PROUDLY MADE BY  
**UltraSource**  
IN THE USA

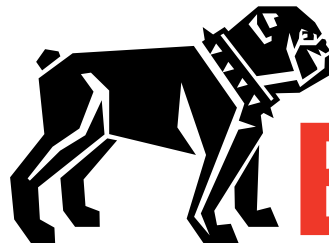

## BULLDOG®

### A LOT OF BITE IN A SMALLER PACKAGE

Economically priced, compact 10 foot frame, and high end features, like remote cameras for low cost and fast support.

10 FT. FRAME  
COMPACT

**PICK 5  
FOR \$99K**

**GET A BULLDOG®  
WITH YOUR  
PICK OF ANY  
5 OPTIONS!**

\* Up to 4 track 2 row type dividers

\*\* Up to 5 rolls per month of  
standard in-stock film

Shipping and taxes not included in bundle price.

- Gas flushing
- Vacuum canister trim removal system
- Upgrade flying knife to guillotine for zig-zag, ez open packages
- Upgrade to 10 inch touch screen with pendant arm
- Automatic chain oiler
- Photo registration for pre-printed non-form film
- Water re-circulator
- CCI reciprocating code date system with 1 head
- Roller discharge
- Second divider set\*
- 3 months free film\*\*
- Easy open peel corner or header
- Second bladder knife
- Trim wind up



## BISON®

### GROW YOUR BUSINESS WITH THE EXPANDABLE BISON® ROLLSTOCK MACHINE

Solid, reliable, intelligent, and expandable, the Bison is 100% US built tough with high cycles per minute (CPM) output rate. Shown below with UltraSource Matrix CrossWeb Package labeler configuration.

PROUDLY MADE BY  
**UltraSource**  
IN THE USA



20 ft. Bison with extended discharge, knee free area, and UltraSource Matrix™ Crossweb Labeler



# FREE! TINTED SAFETY GLASSES



GET FREE SHIPPING & ULTRASOURCE TINTED SAFETY GLASSES WHILE SUPPLIES LAST. JUST ADD ITEM #445049 WITH ANY \$350 ORDER. LIMIT ONE PER CUSTOMER. DISCOUNTS APPLIED IN CART.

**OPERATIONAL SUPPLIES:** 888.997.6824  
**EQUIPMENT & PARTS:** 800.777.5624



We accept Visa, MasterCard, American Express, and Discover  
**SOURCE CODE:** 585



**FREE SHIPPING!**

We offer free shipping on orders totaling \$350 or more for qualified items. Free shipping is not included on expedited, priority, or LTL shipments. Offer only applies to the 48 contiguous states.

Offers good through December 31, 2019.  
PRICES SUBJECT TO CHANGE.

## Ultravac<sup>®</sup> 2100

**PICK 2!**

GET AN ULTRAVAC 2100 WITH YOUR PICK OF ANY 2 OPTIONS FOR ONLY

**\$16,495**



**#1 BEST SELLING & AMERICAN MADE**

## UP TO A \$2,900 VALUE! ULTIMATE ULTRAVAC 2100 VACUUM PACKAGING BUNDLE

- Upgrade from 8" to 12" Depth Lid
- Pre Cut Knife System
- Spare Parts Kit
- Caster Wheels
- Inline Filter
- 10mm Wide Band Seal
- GAS Flush
- Vacuum Pump HP Upgrade
- Clear View Filter

SEE PAGE 36 FOR MORE INFORMATION